



**MKR**

cleaning  
systems  
for liquids



**PURE. SUSTAINABLE. EFFECTIVE.**

**MKR – ABOUT US**  
PAGE 04

**01 VACUUM AND FILTER TROLLEY**  
PAGE 10

**02 EVAPORATORS**  
PAGE 20

**03 ULTRAFILTRATION**  
PAGE 36

**A SOLUTION FOR EVERY PROBLEM**  
PAGE 46

**PRODUCTS AT A GLANCE**  
PAGE 48

**CONTACT**  
PAGE 50



## WATER – A VALUABLE ASSET...

Equipment for water recycling? Many business still think such systems are at most “nice-to-have.” yet the facts and figures and greater environmental awareness say something else: Nowadays, water recycling is an absolute “must have.”

Clean water is increasingly becoming a scarce and thus a valuable asset. The same naturally also applies to all kinds of liquids necessary for industrial production processes. For three decades, MKR has enabled intelligent handling of process media. Our company offers modular problem solutions for the ecological and economic optimisation of production cycles. MKR systems recycle ally kinds of process media. Cleaning and treatment makes them recoverable and reusable – a cycle results, which ensures more productivity and effectiveness. Positive for your profit and loss account and for your environmental balance. With our expert advice for an intelligent, customised recycling solution, you can save energy, work and cash and increase the productivity and effectiveness of your company significantly. We would be pleased to contact you in person, if you have any questions, need a quotation or other information!





Anderl and Thomas Metzger

## A SUCCESS STORY – TRADITION BECOMES INNOVATION.

A brilliant idea of the founder, Anderl Metzger, was the foundation stone: The MKR Metzger company can now look back on three successful decades, in which it developed from a one-man business into an internationally operating, innovative company.

As a sales representative in the chemicals industry, Anderl Metzger recognised the economic potential of more sustainable handling of liquids. In 1990 he became self-employed in Monheim. A mobile high-performance filtering unit for removing tramp oils and particles from process media was the first product of the once one-man operation, MKR Metzger.

In response to the urging of customers, further innovations for economic reclamation of liquid media followed. Centrifuge technology for (ultra-)filtration was added. The family business MKR uses evaporation to reduce ever-increasing disposal costs.

Know-how and problems solutions from MKR are frequently used in metalworking production firms; these include suppliers of the automotive industry in Europe, North America and Asia. Other customer groups include companies specialised in coating as well the disposal of hazardous waste.

MKR now has more than 55 employees in Monheim who work in: consulting, development, design, sales, service and administration.

Support for customers abroad is provided by our sales department and long-standing local partners.

### MKR AT A GLANCE

#### MANAGEMENT

ANDERL AND THOMAS METZGER

#### NUMBER OF EMPLOYEES

OVER 55

(IN CONSULTING, DEVELOPMENT, DESIGN, SALES, SERVICE AND ADMINISTRATION)

#### BASED IN MONHEIM

(SWABIA, GERMANY)

#### EXPORT

WORLDWIDE, TO MORE THAN 40 COUNTRIES

#### CUSTOMERS / INDUSTRIES

- \_ METALWORKING
- \_ DISPOSAL
- \_ COATING
- \_ BIOGAS



Our company building in Monheim/Germany

## TODAY

MKR has developed into a worldwide operating company with more than 55 employees.

## 2015

Custom-fit: Four different evaporator systems for customised solutions



## 2010

In total, more than 3000 units sold worldwide. The RVB evaporator series enables recoverable materials to be obtained from wastewater.

## 2001

The company building moved into in 1996 was not extended until 2001. After building a sales and training wing, planning begins on further expansion of the production capacity.



## 1997

Market launch of vacuum evaporators for treating metalworking fluid, washing water and process water.



## 1990

Anderl Metzger establishes the company "Metzger Kühlschmierstoff-Recycling" (MKR – Metzger metalworking fluid recycling) and develops the first MKR vacuum and filter trolley.



# FROM COMPETENT ADVICE THROUGH TO INTELLIGENT SOLUTION.

We offer you a full service from A to Z.



## ADVICE // SERVICE

The MKR team has set itself the standard of providing competent customer advice under ecological and economical aspects. Depending on the initial situation, our customers' priorities are economy, targeted problem solution and added value.

## REMOTE MAINTENANCE

We focus on maximum plant availability. Whether our hotline, remote diagnostics, or deployment on site, our trained service personnel ensure optimum effectiveness – a whole life long. Fast spare parts supply and maintenance agreements round off the service portfolio.



## LABORATORY // DEVELOPMENT

At the beginning there is an idea and the announced customer benefit. Fluids are analysed and documented in our own laboratory, so that we can then demonstrate the practicability of the idea in the MKR technical centre. All kinds of different machines and systems are available for this and ensure perfect optimisation potential.



## DESIGN

All system components are designed and calculated by MKR, down to the smallest detail. This involves concentrating all know-how in the company, which ultimately also helps to supply spare parts quickly at a later date.



## PRODUCTION

The above-average production depth of MKR ensures maximum flexibility and quality of the products.

From the control cabinet to the mechanics and structural steelwork through to surface treatment, almost everything is produced in-house by our long-standing MKR employees.

# UNBEATABLE ARGUMENTS – 6 REASONS FOR MKR.



## EFFECTIVE

INCREASE PRODUCTIVITY,  
SAVE COSTS

MKR units enable top productivity for low energy consumption. You also save valuable working hours and relieve your employees' workload. The simple and fast handling of the units also contribute to their effectiveness.



## LONG-LASTING

SAVE REPAIR COSTS

Many of our customers are surprised by the durability of MKR units and the low repair costs. Furthermore we put emphasis on quick and simple maintenance.



## INNOVATIVE

USE THE LATEST TECHNOLOGIES

MKR recycling systems operate with the latest technologies. MKR's "evaporator" technology is unique and superior compared to the competition.



## SUSTAINABLE

SAVE RESOURCES & ENERGY

MKR units have a low energy requirement and high distillate quality. You also save cash and do something good for the environment.



## COMPETENT

BENEFIT FROM  
EXPERT ADVICE

Benefit from competent, expert advice plus services from A to Z. Thanks to their long-standing experience, our consultants also impress through their outstanding expertise.



## MODULAR

RECEIVE CUSTOMISED SOLUTIONS

We have the solution to every problem. You receive an intelligent, effective solution, tailored to your specific needs.

# LOWER DISPOSAL COSTS MEAN HIGHER PROFITS.

With our MKR units you save costs, effort, time and energy. Our units enable high overall cost savings as well as a distinct productivity increase for your company.

Contamination of process media due to tramp oils, ultrafine particles and microorganisms, limits the operating time of industrial production plants, in some cases substantially. MKR recycling systems eliminate such interfering factors effectively by means of filtration, separation and treatment units. As a result, metal-working fluids, cutting oils, washing fluids and other process media remain usable for significantly longer. This means: lower (disposal) costs and higher profits.

Investments in the cleaning and reclamation of process media pay in many respects. They not only enable cost

savings for energy, material, labour costs and disposal. The recycling of process media also ensures a uniformly high quality and more efficiency in production.

Our company offers modular problem solutions for the ecological and economic optimisation of production cycles with liquid requirements. The consistent reclamation of process media with the know-how and units of MKR produces economic and ecological benefits for your company. It means real sustainability – in the interest of the successful future of your company and in the interests of the environment and careful use of resources.



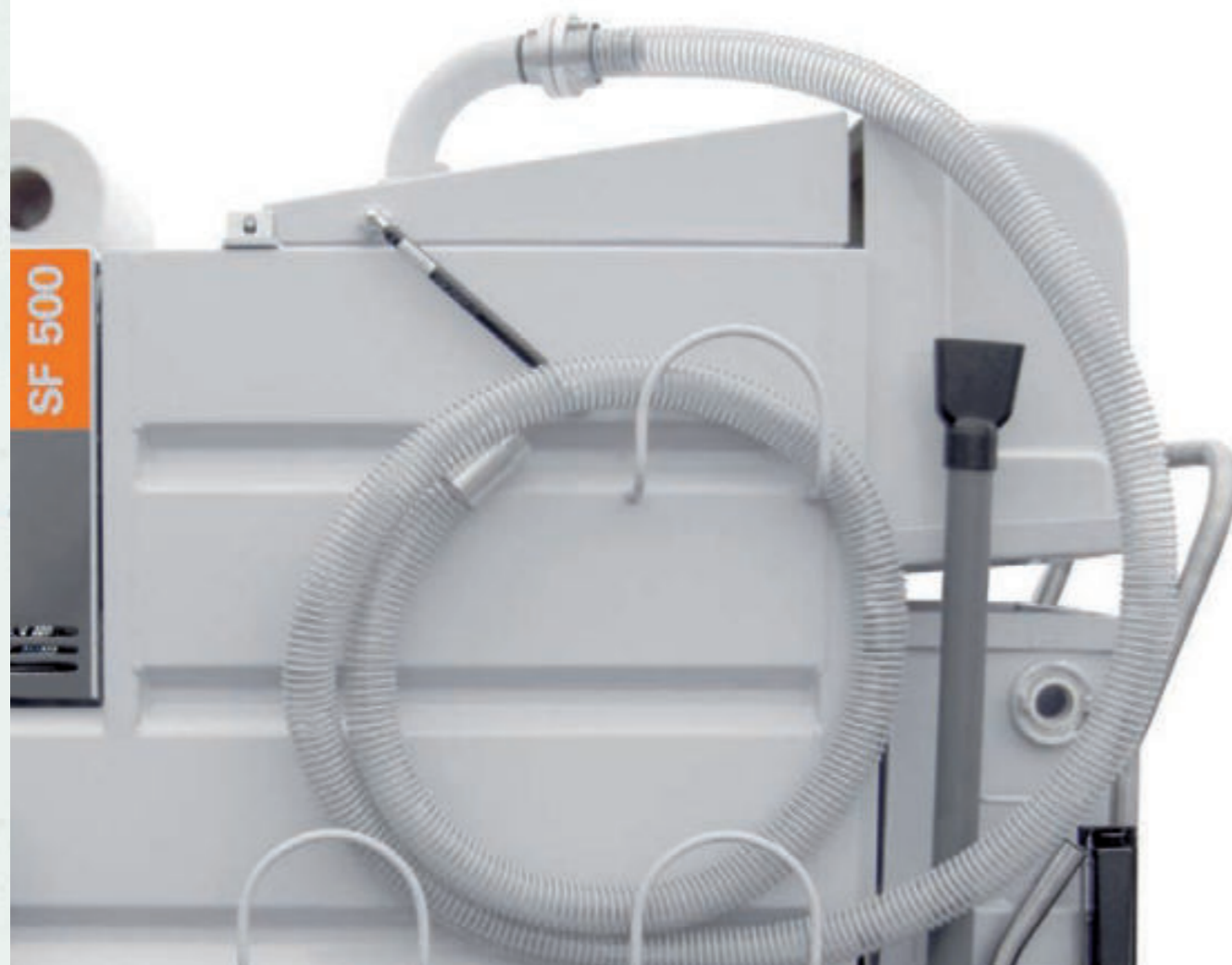

# 01

## 01 VACUUM AND FILTER TROLLEYS

01/1	<b>THE PERFECT SOLUTION</b>	PAGE 12
01/2	<b>THE ADVANTAGES</b>	PAGE 13
01/3	<b>THE ECONOMY</b>	PAGE 13
01/4	<b>APPLICATION &amp; AREAS OF USE</b>	PAGE 14
01/5	<b>THE FUNCTIONS</b>	PAGE 14
01/6	<b>THE PROCESS / DIAGRAM</b>	PAGE 15
01/7	<b>THE CLEANING HOSE OPTION</b>	PAGE 15
01/8	<b>A LOOK AT THE TECHNOLOGY</b>	PAGE 16
01/9	<b>TECHNICAL DATA</b>	PAGE 18

01/1 VACUUM AND FILTER TROLLEYS // THE PERFECT SOLUTION

# SAVE TIME AND COSTS FOR THE INDUSTRIAL SPRING CLEAN.

Fast and easy complete cleaning of all your machine tools



UP TO **8 h**

STRENUOUS AND TIME-CONSUMING

TIME-CONSUMING  
SHORTENED SERVICE LIFE  
HIGH COSTS



APPROX. **0,5 h**

EFFICIENT AND ECONOMICAL

TIME-SAVING  
EXTENDED SERVICE LIFE  
LOW COSTS

01/2 VACUUM AND FILTER TROLLEYS // THE ADVANTAGES

# MAKE YOUR COMPANY MORE PRODUCTIVE.

Complete industrial cleaning was previously strenuous: With industrial vacuum cleaners, high-pressure cleaners, oil shovels, protective gloves and cloths were all used to get to grips with the dirt, some highly toxic, manually. Depending on the size of the operation, it can take hours of strenuous work until all elements are clean – valuable working time was lost ... That was the past.

Our intelligent, perfectly thought-through vacuum and filter trolleys enable complete cleaning in only 30 minutes. And what's best of all: You save time, energy, valuable manpower and increase the productivity of your company significantly in the long-term.

THE ADVANTAGES AT A GLANCE

- ✓ PERFECT EMULSION MAINTENANCE FOR INDIVIDUALLY FILLED MACHINES
- ✓ EMULSION CHANGE IN A VERY SHORT TIME
- ✓ SHORT MACHINE STANDSTILL TIMES
- ✓ VERY SIMPLE HANDLING
- ✓ CAN BE USED FOR METALWORKING FLUIDS OR CUTTING AND MACHINING OILS



01/3 VACUUM AND FILTER TROLLEYS // THE ECONOMY

# FIGURES, THAT SPEAK FOR THEMSELVES.

UP TO **-85%**  
COST SAVINGS IN TOTAL

UP TO **+15%**  
MACHINE AVAILABILITY

UP TO **91%**  
TIME SAVING

01/4 VACUUM AND FILTER TROLLEYS // APPLICATION & AREAS OF USE

# COMPLICATED? WRONG.

Simply go to the machining plant and clean it in next to no time: That's how easy it is with the mobile MKR units for complete cleaning. They can be used to extract, care and then return 500 litre of contaminated metalworking fluid to the production process in only 15 minutes, including cleaning the metalworking fluid tank.

The high-performance MKR units type **SF 250**, **SF 500**, **SF 700** and **SF 1000** combine several cleaning methods in one system: Liquid and swage suction apparatus, vacuum filter and high-pressure cleaner. The integrated swarf remover deals with solids and swage; liquids are cleaned by passing them through a vacuum filter.

The drained machine tank is cleaned using the high-pressure lance. The maintained liquid is returned to the cleaned machine by the return pump, while the tramp oils remain in the cleaning unit.

- AREAS OF USE**
- ✓ METALWORKING FLUID CARE
  - ✓ CUTTING OIL CLEANING
  - ✓ CLEANING OF THE INTERNAL SPACES OF MACHINES AND TANKS
  - ✓ COMPLETE CLEANING OF EMULSION TANKS
  - ✓ EXTRACTION OF FLOATING TRAMP OILS
  - ✓ COLLECTION OF SWARF AND GRINDING SLUDGE

01/5 VACUUM AND FILTER TROLLEYS // THE FUNCTIONS

## 4 FUNCTIONS IN ONE UNIT.

### I. EXTRACTION

Swarf and grinding swarf are extracted reliably from soiled metalworking fluids using the suction spout. The high suction and pumping capacity of the MKR unit minimises the time required to clean machines and emulsions.

### II. FILTERING

Thanks to vacuum filters, chips (swarf) and grinding sediments up to 60 µm in size are separated from the emulsion reliably.

### III. HIGH-PRESSURE LANCE

It can even flush out stubborn deposits and oily dirt – cleanliness through to the smallest corner of the machine interior.

### IV. SWARF REMOVER

It absorbs the metal particles filtered out of the medium; it can also be used as an independent vacuum cleaner.

01/6 VACUUM AND FILTER TROLLEYS // THE PROCESS / DIAGRAM

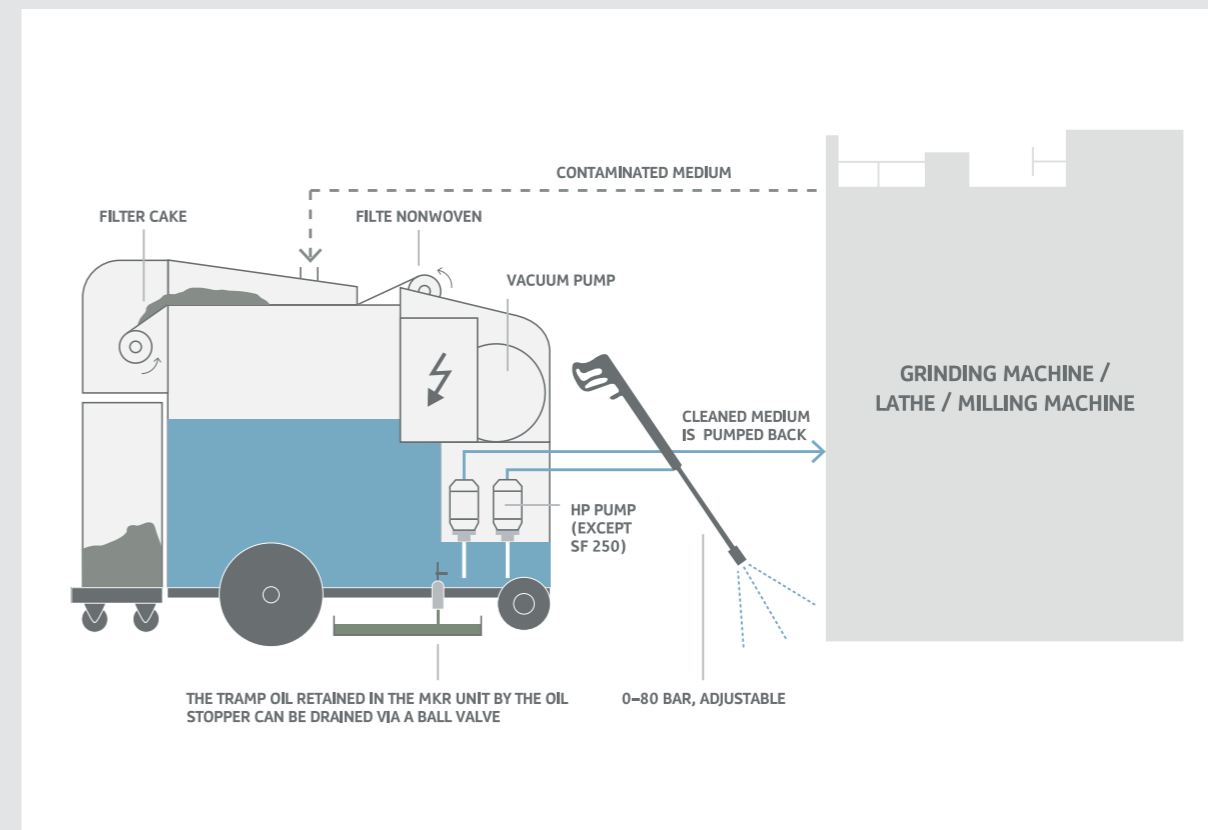

01/7 VACUUM AND FILTER TROLLEYS // THE CLEANING HOSE OPTION

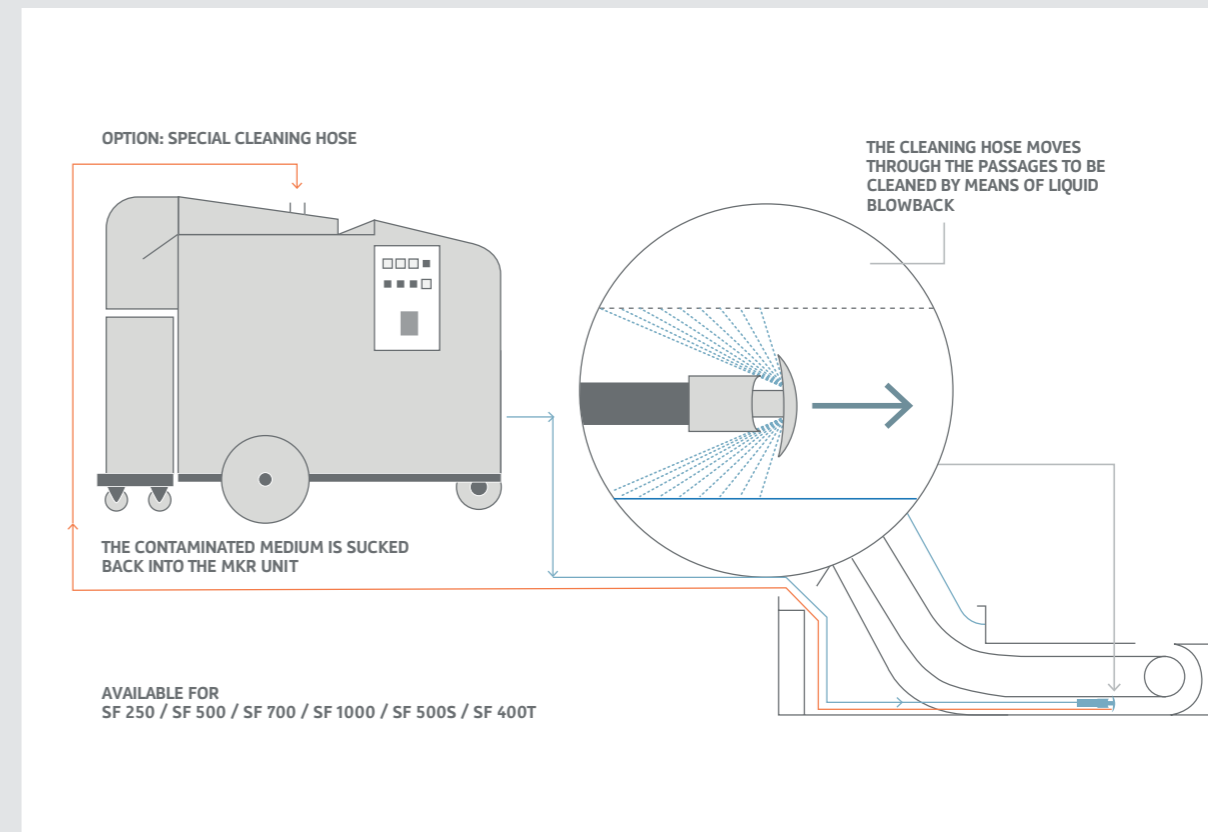



# INTELLIGENTLY DESIGNED – 10 TECHNICAL HIGHLIGHTS.



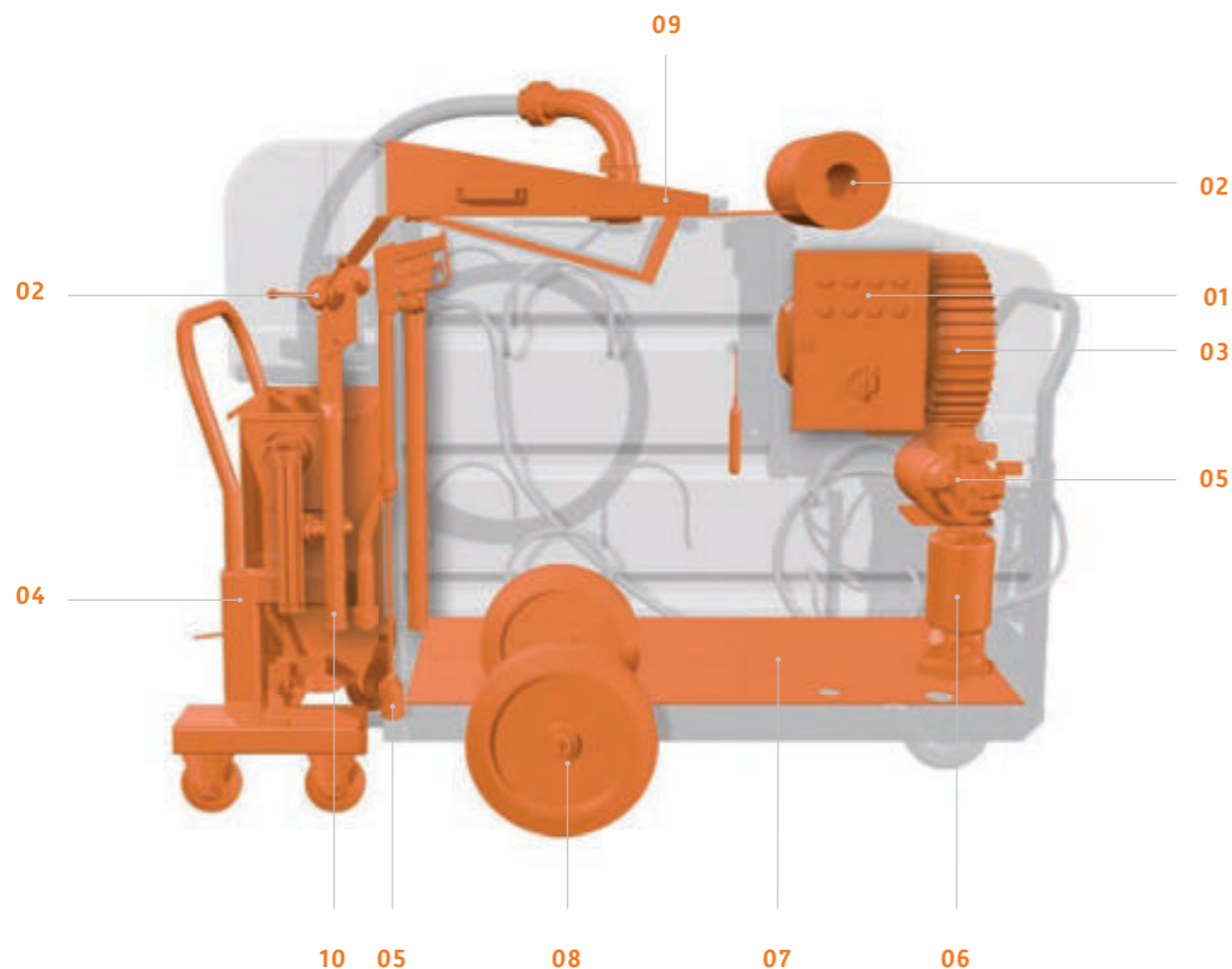







Our vacuum and filter trolleys are perfectly thought-through and are tailored to the needs of our customers. This guarantees effectiveness and time savings.



The MKR vacuum and filter trolleys have intelligent, state-of-the-art technology. The efficiency and simplest possible handling of our SF series was a major concern of ours from the outset, during the development and design. And our engineers achieved their goal:

many elements help to achieve simple handling and maintenance and save the user valuable time, work and effort. Powerful pumps and practical tools for fast cleaning also reasons why MKR vacuum and filter trolleys are now indispensable.



<p><b>01</b></p>  <p><b>EASY OPERATION</b></p> <p>Easy and convenient operation of the three functions (extraction, high-pressure cleaning and draining).</p>	<p><b>02</b></p>  <p><b>EFFICIENT FILTER NONWOVEN</b></p> <p>Efficient filter nonwoven with a particle rating of up to 60 µm. The integrated manual nonwoven reel ensures easy separation of the filter cake from the nonwoven.</p>
<p><b>03</b></p>  <p><b>HIGH-SUCTION VACUUM PUMP</b></p> <p>High-suction pump for extracting the process medium to be cleaned. At the same time, it can be combined with the unit's other functions.</p>	<p><b>04</b></p>  <p><b>CONVENIENT DISPOSAL</b></p> <p>Integrated and mobile swarf trolley (with fork-lift pockets and pivotable) for convenient pick-up and draining of the separated substances.</p>
<p><b>05</b></p>  <p><b>POWERFUL HIGH-PRESSURE LANCE</b></p> <p>Powerful high-pressure pump for operating the high-pressure lance (up to 80 bar).</p>	<p><b>06</b></p>  <p><b>EFFICIENT DRAINING PUMP</b></p> <p>Efficient draining pump for returning the cleaned medium to the production cycle (for example, in a machine tool).</p>
<p><b>07</b></p>  <p><b>CONVENIENT DRAINING</b></p> <p>Inclined bottom for complete draining of the cleaned medium with level monitoring sensor.</p>	<p><b>08</b></p>  <p><b>OPTIMUM FREEDOM OF MOVEMENT</b></p> <p>Large wheels (diameter 400 mm) for optimal Freedom of movement in the production facility</p>
<p><b>09</b></p>  <p><b>EASY CLEANING</b></p> <p>Beste Zugänglichkeit zur Excellent accessibility for easy cleaning of the equipment including a further optional cleaning opening.</p>	<p><b>10</b></p>  <p><b>SELECTION OF SUCTION NOZZLES</b></p> <p>Large choice of different suction nozzles included (clean and space-saving stowability including drip try).</p>

# VACUUM AND FILTER TROLLEYS – THE TECHNOLOGY IN DETAIL.



## SF 250

UNIT VALUE

Capacity		
Main tank	approx. l	250
Swarf tray	approx. l	20

Dimensions		
Length	mm	1750
Width	mm	725
Height	mm	1250
Empty weight	kg	310

Suction head (stat.) mm WS		2000
Suction capacity	l/min	125
Temperature	°C	< 50
pH-value	pH	5 – 9,5
Noise level	dB (A)	< 75
Power connection	V/A	230/16
1 phase, N and PE	Hz	50
Connected load	kW/A	2,5/16

## SF 500

UNIT VALUE

Capacity		
Main tank	approx. l	500
Swarf remover	approx. l	60

Dimensions		
Length	mm	2000
Width	mm	800
Height	mm	1600
Empty weight	kg	420

Suction head (stat.) mm WS		2800
Intake flow	l/min	250
Temperature	°C	< 50
pH-value	pH	5 – 9,5
Noise level	dB (A)	73
Power connection	VA	400/16
3 phases, PE	Hz	50
Connected load	kW/A	7/16

## SF 700

UNIT VALUE

Capacity		
Main tank	approx. l	700
Swarf remover	approx. l	80

Dimensions		
Length	mm	2400
Width	mm	920
Height	mm	1600
Empty weight	kg	560

Suction head (stat.) mm WS		3700
Intake flow	l/min	320
Temperature	°C	< 50
pH-value	pH	5 – 9,5
Noise level	dB (A)	75
Power connection	VA	400/16
3 phases, PE	Hz	50
Connected load	kW/A	7/16

## SF 1000

UNIT VALUE

Capacity		
Main tank	approx. l	1000
Swarf remover	approx. l	80

Dimensions		
Length	mm	2930
Width	mm	920
Height	mm	1600
Empty weight	kg	690

Suction head (stat.) mm WS		3700
Intake flow	l/min	320
Temperature	°C	< 50
pH-value	pH	5 – 9,5
Noise level	dB (A)	75
Power connection	VA	400/16
3 phases, PE	Hz	50
Connected load	kW/A	7/16

## SF 400 T

UNIT VALUE

Capacity		
Main tank	approx. l	400
Swarf remover	approx. l	80
Oil tank	approx. l	50

Dimensions		
Length	mm	2900
Width	mm	910
Height	mm	1500
Empty weight	kg	865

Suction head (stat.) mm/WS		2600
Intake flow	l/min	250
Temperature max.	°C	< 50
pH-value	pH	5 – 9,5
Separator flow rate	l/h	800–3000
Separation particle size	µm	2 – 5
Noise level	dB(A)	78
Power connection	V/A	400/16
3 phases, PE	Hz	50
Connected load	kW/A	5,5/13

## SF 500 S

UNIT VALUE

Capacity		
Main tank	approx. l	400
Clean tank	approx. l	160
Oil tank	approx. l	25
Swarf remover	approx. l	80

Dimensions		
Length	mm	2700
Width	mm	920
Height	mm	1500
Empty weight	kg	630

Suction head (stat.) mm WS		2600
Intake flow	l/min	250
Separator flow rate	l/h	500
Separation particle size	µm	> 2
Temperature	°C	< 50
pH-value	pH	5 – 9,5
Noise level	dB (A)	75
Power connection	V/A	400/16
3 phases, PE	Hz	50
Connected load	kW	9/16

# 02



## 02 EVAPORATORS

02/1	THE PERFECT SOLUTION	PAGE 22
02/2	THE ADVANTAGES	PAGE 23
02/3	THE ECONOMY	PAGE 23
02/4	THE PROCESS	PAGE 24
02/5	THE PROCESS / DIAGRAM	PAGE 25
02/6	AREAS OF USE & PERFORMANCE CHARACTERISTICS	PAGE 25
02/7	THE INDUSTRIES	PAGE 26
02/8	A LOOK AT THE TECHNOLOGY	PAGE 28
02/9	THE PERIPHERAL EQUIPMENT	PAGE 32
02/10	TECHNICAL DATA	PAGE 34

## SAVE TIME, ENERGY AND UP TO 95% OF YOUR DISPOSAL COSTS.

Effective wastewater treatment with the MKR evaporator technology



APPROX. **100 €/t**

BY AN EXTERNAL DISPOSAL COMPANY

HIGH COSTS  
HIGH EFFORT  
TIME-CONSUMING



APPROX. **15 €/t**

WITH MKR EVAPORATOR TECHNOLOGY

LOW COSTS  
LOW EFFORT  
TIME-SAVING

## INCREASE THE EFFICIENCY OF YOUR PRODUCTION CYCLES.

See for yourself the convincingly unbeatable advantages of our MKR evaporator technology. On the following pages we examine the technology, the user-friendliness and the unique selling propositions of our units in detail.

Technically very well thought-through, intelligently designed and controlled, MKR evaporators (ET series) are now indispensable for production cycles with process media.

Low energy consumption, maximum efficiency, lower material consumption (chemicals), top distillate quality, fast and easy maintenance and operability save you valuable time and money. You also relieve the workload of your employees and reduce the impact on the environment.

### THE ADVANTAGES AT A GLANCE

- ✓ LOWEST ENERGY CONSUMPTION
- ✓ LOW RECOVERY AND DISPOSAL COSTS
- ✓ CLEAN CYCLE WATER (DISTILLATE)
- ✓ HIGH-QUALITY, RELIABLE TECHNOLOGY
- ✓ CONTINUOUS, AUTOMATIC OPERATION
- ✓ PRACTICALLY SALT AND HEAVY METAL-FREE DISTILLATE
- ✓ SMALL SPACE REQUIREMENT
- ✓ EASIEST POSSIBLE OPERATION
- ✓ COMPACT DESIGN AND EASY INSTALLATION

## SIMPLY BETTER THAN THE COMPETITION.

UP TO **-90%**

COST SAVINGS IN TOTAL

UP TO **-95%**

DISPOSAL COSTS

UP TO **-30%**

ENERGY CONSUMPTION COMPARED TO THE COMPETITION

## HOW IS MORE EFFICIENCY MADE POSSIBLE? THROUGH MKR EVAPORATOR TECHNOLOGY.

Our evaporator technology is unique and is quick and easy to use. Benefit from energy and material savings, high distillate quality, easy, faster maintenance and high output.

Mechanical vapour compression leads to continuous reuse of the energy contained in the steam. The evaporation heat exchanger of the evaporator with forced flow and consistent use of the heat from the distillate enable the low-energy consumption from 35 watt hours per litre. The compression control and integrated distillate aftertreatment by a coalescer product top distillate qualities.

With this type of evaporator, due to the built-in mechanical defoamer, the addition of defoaming additives is necessary in only a few exceptional cases.

The evaporator operates fully automatically. The sensors monitor the process and prevent system overload.

The system is cleaned fully automatically at fixed intervals. Generously sized doors ensure free access to the machine components. The distillate is hygenised by the high evaporation temperature of approx. 100°C and can be re-used in the production.

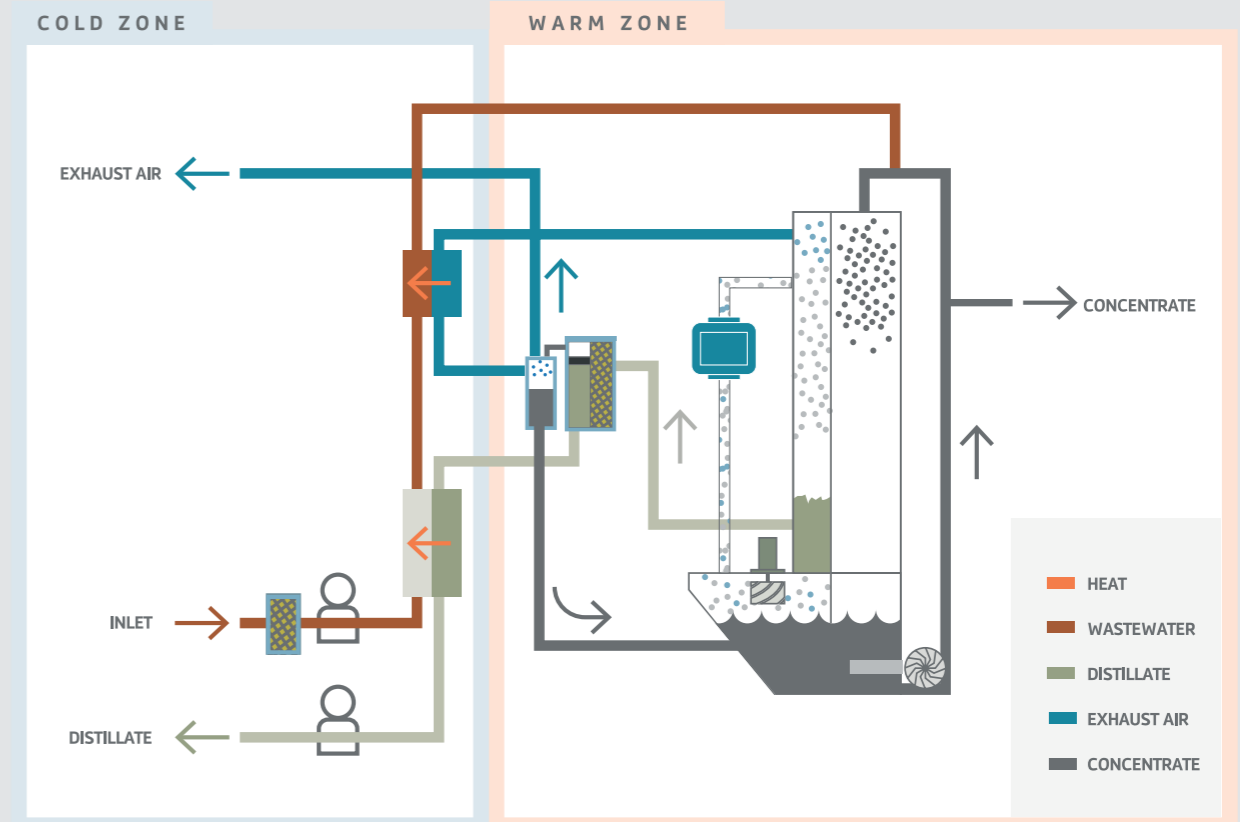

### AREAS OF USE

- ✓ METALWORKING EMULSIONS
- ✓ DIE-CASTING EMULSIONS
- ✓ FLOOR CLEANING WATER
- ✓ WASHING AND DEGREASING BATHS
- ✓ RINSING BATHS
- ✓ PAINTING PRE-TREATMENT

### PERFORMANCE CHARACTERISTICS

- ✓ LOW SPECIFIC ENERGY CONSUMPTION
- ✓ IN GENERAL, USE OF CHEMICAL DEFOAMERS IS NOT NECESSARY
- ✓ VERY SHORT STANDSTILL TIMES FOR CLEANING
- ✓ LOW POWER CONSUMPTION
- ✓ MECHANICAL FOAM BREAKER
- ✓ COMPACT DESIGN
- ✓ HYGENISED DISTILLATE
- ✓ RECOVERY OF PROCESS WATER
- ✓ LOW INPUT TEMPERATURE



## IN WHICH INDUSTRIES ARE MKR EVAPORATORS IN USE?



### METAL MACHINING / WORKING

In the metal producing and metal-working industry, different processes are applied to produce the product in the required form and quality. In the different processes, such as the chip removal, the joining or shaping process, process water is used to cool the workpieces during production. With the help of the evaporator technology, you can clean and reprocess the process water, so that up to 95 % recyclable distillate is produced.



### SURFACE TREATMENT / PAINTING

In surface treatment, for example, painting, coating or even grinding, blasting or brushing, different types of wastewater are produced, depending on the technique. They include washing wastewater, rinsing and active baths or process water from electroplating. This wastewater must normally be disposed of, which is an expensive solution. Thanks to the evaporator technology of MKR, the wastewater types can be treated for the purpose of recycling, so that up to 98 % can be reused in the production process.



### ENERGY GENERATION / SUPPLY

In energy generation and supply, attention is paid to producing a high yield of usable energy, and to do so as economically, efficiently and, of course, as environmentally friendly as possible. However, the technologies used for energy generation, storage and use can also produce wastewater, which in turn harms the environment. Regardless of the constituents of the wastewater, the evaporator technology offers you an individual solution for careful reprocessing and cleaning of wastewater.



### PHARMACEUTICAL / CHEMICAL / PETROCHEMICAL / COSMETIC INDUSTRY

The main products of these industries include plastics, pharmaceutical products, plant production products, as well as organic and inorganic base materials, chemicals and cosmetic products. Many of these products are in everyday use and are produced in very large quantities. Use of water is indispensable for the manufacture and the cleaning processes in production. Wastewater with all kinds of different composition is therefore produced, which can contain the residues of chemicals and paints. The evaporator technology of MKR Metzger takes up this challenge. With the help of the different modules and peripheral equipment of our evaporators, it is possible to satisfy these requirements, to clean the wastewater and to treat it for reuse.



### AUTOMOTIVE / AEROSPACE

Whether in die casting or in electroplating: In the automotive industry and in the aerospace industry, corresponding wastewater is produced in all kinds of different production processes. The wastewater produced can contain all kinds of different substances. With the help of the evaporator technology, wastewater mixed with emulsions is a thing of the past. We offer you individual solutions, to treat the wastewater produced and to return it to the production.



### WASTE DISPOSAL / RECYCLING / RENOVATION

All kinds of different wastewater are produced in the waste disposal and recycling industry, as well as in building renovation. Here too, the wastewater contains all kinds of different substances, depending on the disposal or cleaning process. The typical types of wastewater include: Process water from metal recovery, metal recycling as well as waste minimisation. The evaporator technology of MKR cleans the process water, so that it is suitable for reuse. As a result, expensive disposal costs are avoided and most of the valuable asset water can be saved.

### FOOD / DRINK / FEED

Especially in the food sector, the drinks and feedstuffs industry, extremely high hygiene requirements must be met in production. The water demand in these industries is therefore very high. The resulting wastewater contains proteins, carbohydrates, greases and oils and therefore have a high chemical oxygen demand (COD value). MKR evaporator technology is used to lower this value and to clean the wastewater. We treat the wastewater and return the water, for the purpose of recycling, back into the production so that as many resources as possible are used carefully.

## MAXIMUM EFFICIENCY – 6 TECHNICAL HIGHLIGHTS.

See for yourself the convincingly intelligent layout of MKR evaporators.

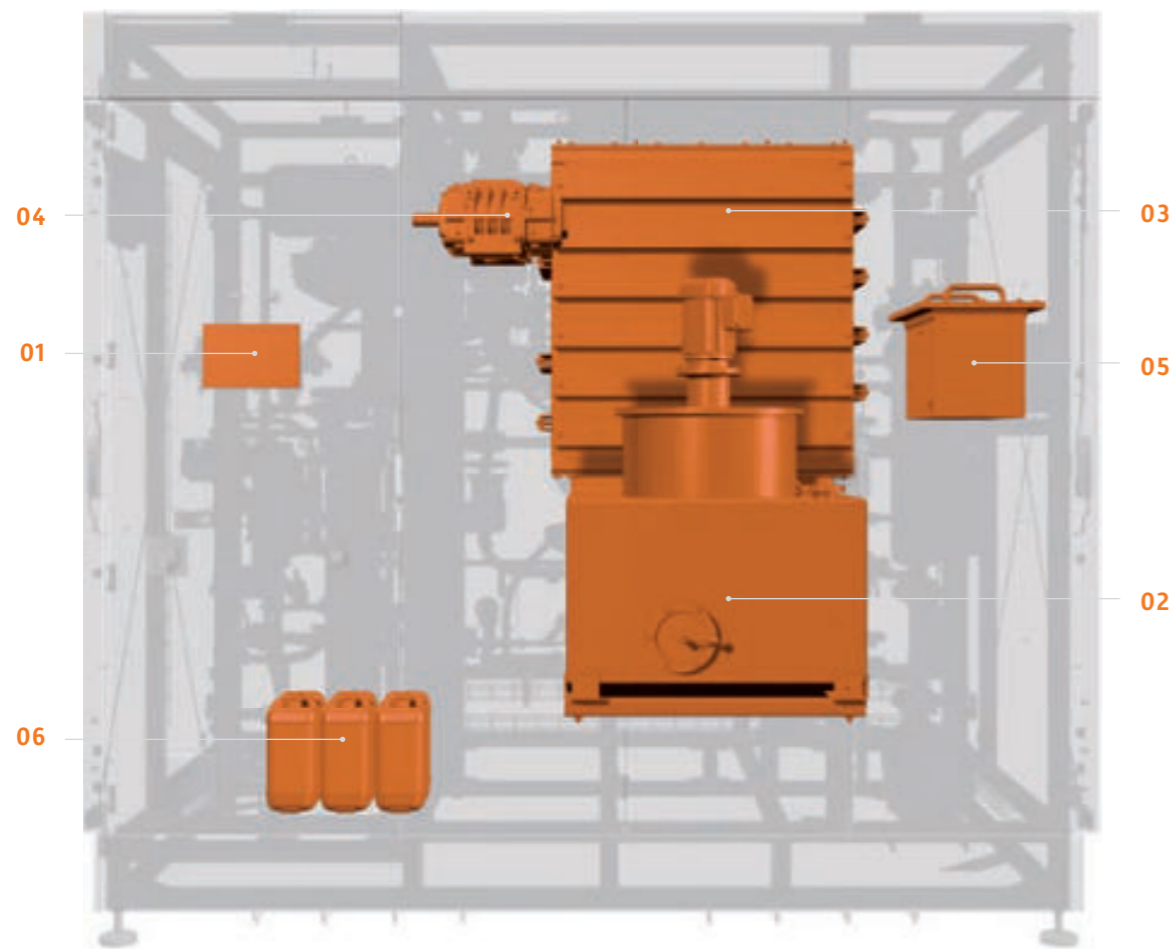

MKR evaporator technology is superior to the competition when it comes to efficiency and economy. Based on overpressure, it was especially developed by MKR – in contrast to the underpressure methods used by competitors.

By comparison, MKR evaporators are therefore use up to 50% less energy and are more effective than competitor products.

See for yourself the convincing advantages of our evaporators on the following pages: From the fast and easy operability, the low energy consumption through to the high performance.

01

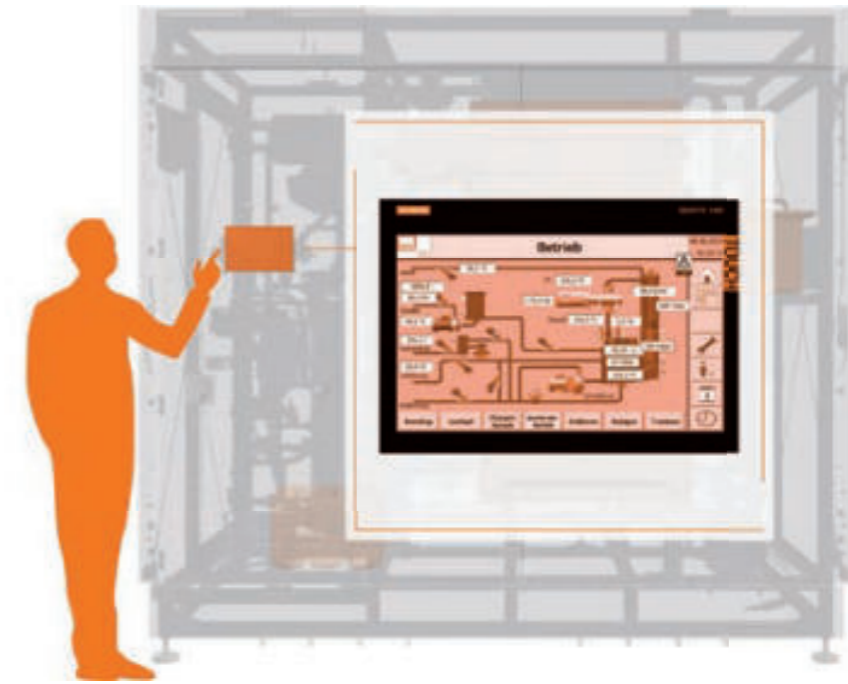

### 19 % MORE OUTPUT THROUGH INTELLIGENT CONTROL

Intelligent and simple system control enables maximum utilisation of the energy used. Up to 400 hours of continuous operation without loss in performance is possible, whereby 19 % more output is achieved than conventional vacuum evaporators.

02

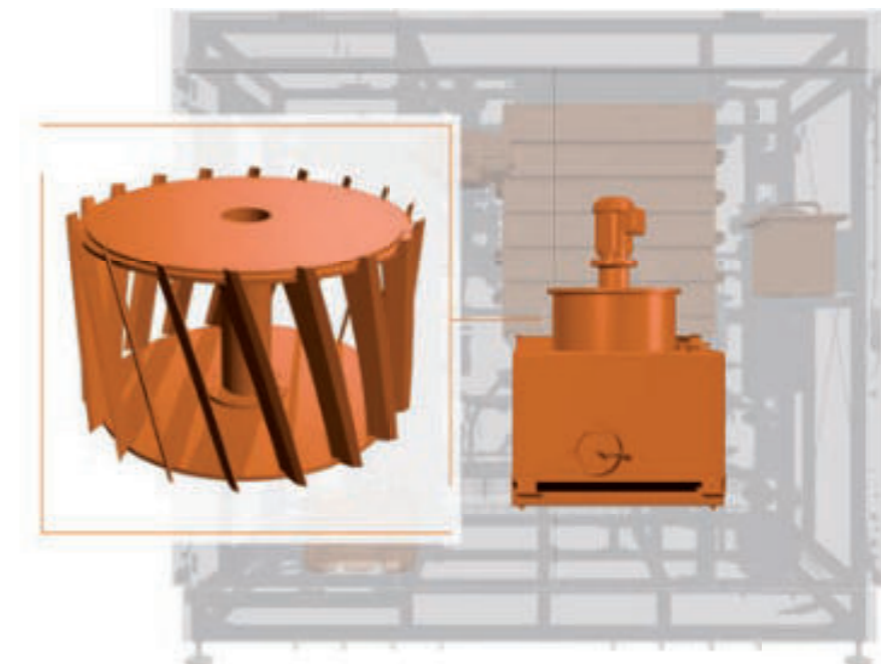

### CENTRIFUGAL DEFOAMER

Centrifugal-mechanical defoamers for steam treatment for the highest standards (therefore reduced defoamer chemicals). Top distillate quality is therefore produced.

03

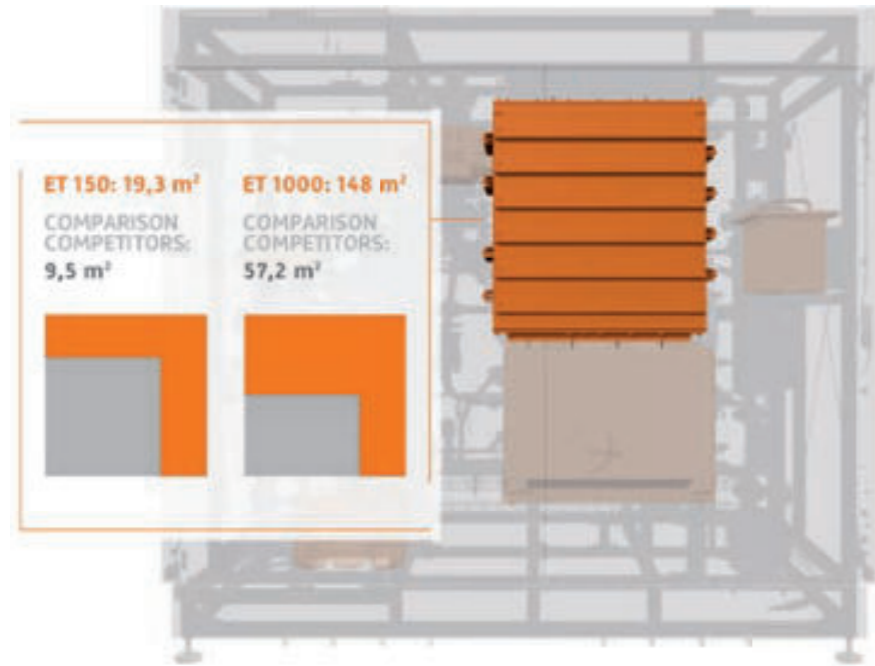

#### 50 % MORE EFFICIENT DUE TO LOW ENERGY COSTS

The largest evaporation heat exchanger of its class, which leads to very "gentle" evaporation. The forced circulation system prevents encrustations and enables high energy recovery.

04

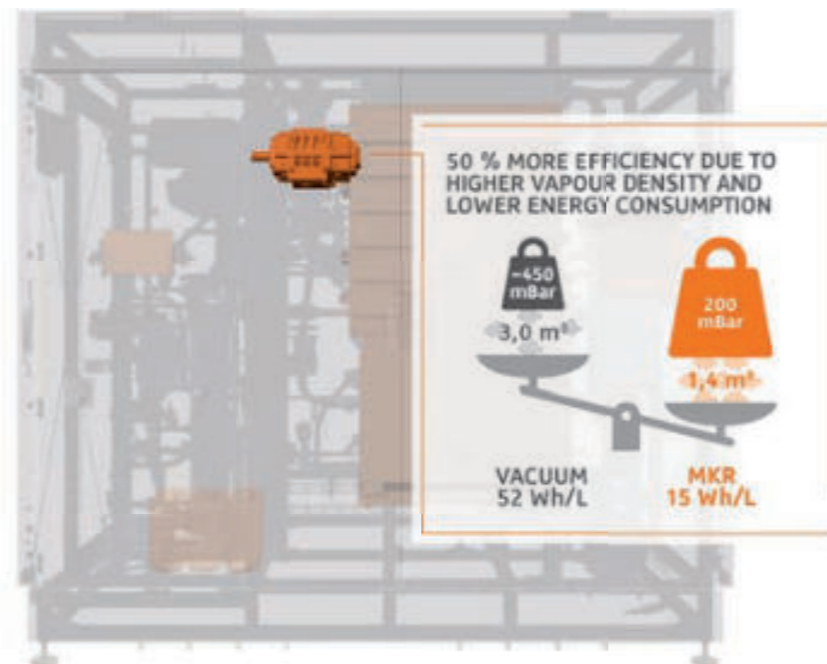

#### HIGH ENERGY RECOVERY

The compressor reduces the mechanical work through the highest vapour density (up to 50 % more efficient than vacuum evaporators). 3-stage recuperation achieves smaller energy losses, which means lower energy costs.

05

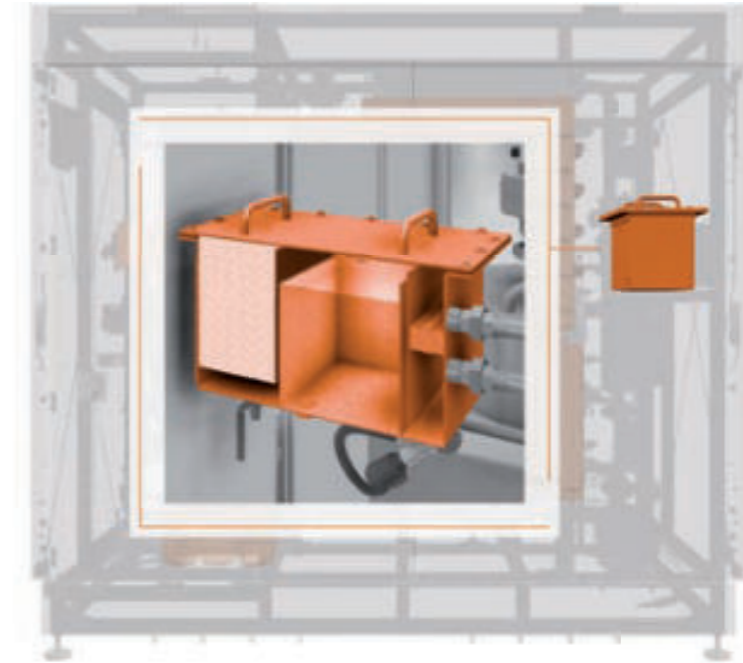

#### HIGHEST DISTILLATE QUALITY

Top distillate quality due to coalescence-combination technology.

06

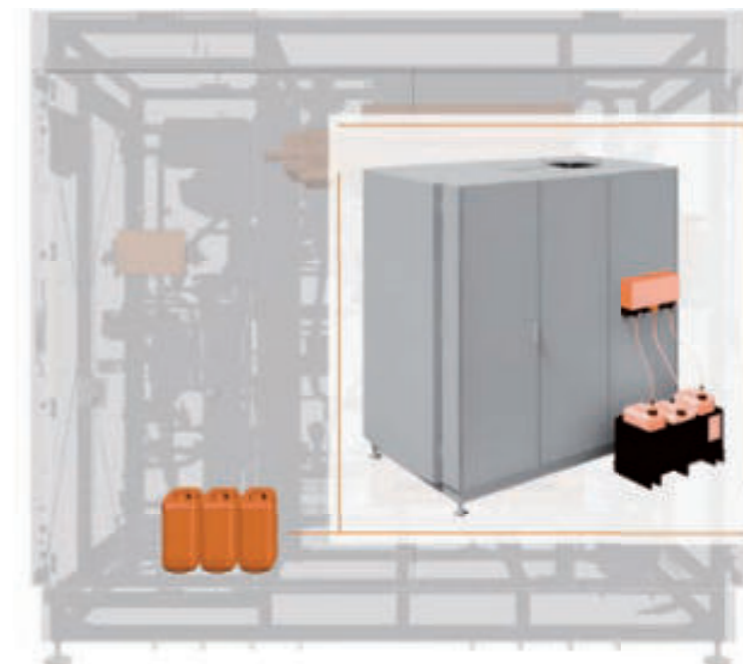

#### AUTOMATIC CLEANING / LOW COSTS

Automatic and exact dosing of the chemicals is achieved through the integrated and forced circulation high-pressure cleaning, which means a buffer tank is not necessary. Extremely long machining cycles (up to 400 h) save costs for cleaning chemicals and ensure low standstill times.



## FLEXIBLE DUE TO MODULAR PERIPHERAL EQUIPMENT.

MKR evaporator units adapted to your wishes, individually configurable

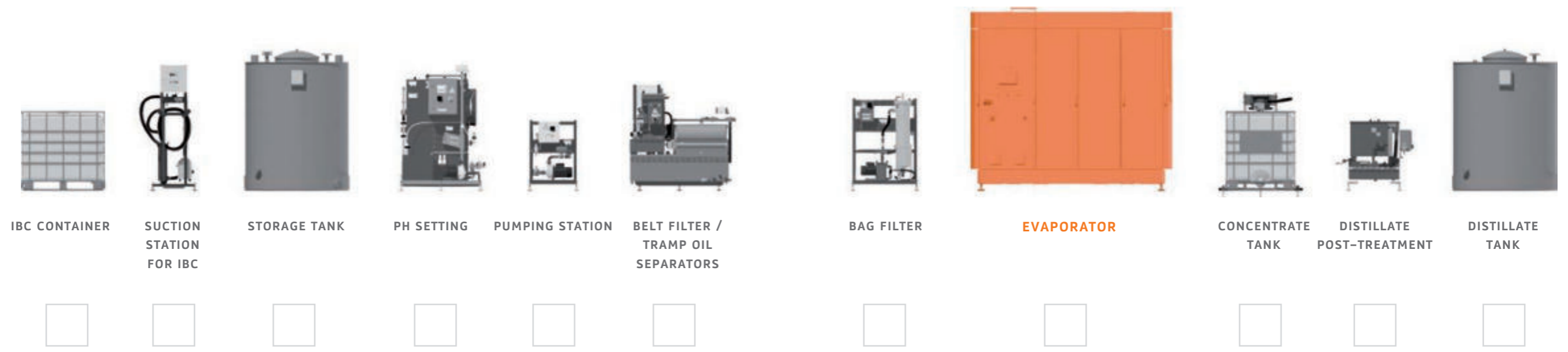

Thanks to the modular design of the MKR evaporator systems, we are able to meet the wishes of our customers. The modules can be installed with the initial purchase, or can be easily retrofitted later.

In a joint discussion, we work up the suitable solutions for your problem and can optimally match our MKR evaporator systems to your needs.

# THE EVAPORATOR TECHNOLOGY IN DETAIL.

## ET 50

	UNIT	VALUE
Nominal output	l/h	50
Energy requirement in operation	kWh/m <sup>3</sup>	from 65
<b>Dimensions</b>		
Length	mm	1950
Width	mm	1260
Height	mm	2400
Empty weight	kg	2100
Noise level	dB (A)	< 72
Power connection		clockwise
Voltage		3x400V/N/PE
Frequency	Hz	50
Current intensity	A	52
Connected load	kW	32
Air quantity	NI/min	100
Air quantity Peak demand	NI/min	300
Media temperature	°C	10 – 60
pH-value	pH	6,5 – 11

## ET 100

	UNIT	VALUE
Nominal output	l/h	100
Energy requirement in operation	kWh/m <sup>3</sup>	from 60
<b>Dimensions</b>		
Length	mm	1950
Width	mm	1260
Height	mm	2400
Empty weight	kg	2100
Noise level	dB (A)	< 72
Power connection		clockwise
Voltage		3x400V/N/PE
Frequency	Hz	50
Current intensity	A	52
Connected load	kW	32
Air quantity	NI/min	100
Air quantity Peak demand	NI/min	300
Media temperature	°C	10 – 60
pH-value	pH	6,5 – 11

## ET 150

	UNIT	VALUE
Nominal output	l/h	150
Energy requirement in operation	kWh/m <sup>3</sup>	from 55
<b>Dimensions</b>		
Length	mm	2500
Width	mm	1580
Height	mm	2600
Empty weight	kg	2300
Noise level	dB (A)	< 76
Power connection		clockwise
Voltage		3x400V/N/PE
Frequency	Hz	50
Current intensity	A	63
Connected load	kW	39
Air quantity	NI/min	100
Air quantity Peak demand	NI/min	300
Media temperature	°C	10 – 60
pH-value	pH	6,5 – 11

## ET 500

	UNIT	VALUE
Nominal output	l/h	500
Energy requirement in operation	kWh/m <sup>3</sup>	from 35
<b>Dimensions</b>		
Length	mm	4450
Width	mm	2350
Height	mm	3100
Empty weight	kg	4800
Noise level	dB (A)	< 76
Power connection		clockwise
Voltage		3x400V/N/PE
Frequency	Hz	50
Current intensity	A	105
Connected load	kW	64
Air quantity	NI/min	200
Air quantity Peak demand	NI/min	600
Media temperature	°C	10 – 60
pH-value	pH	6,5 – 11

## ET 750

	UNIT	VALUE
Nominal output	l/h	750
Energy requirement in operation	kWh/m <sup>3</sup>	from 35
<b>Dimensions</b>		
Length	mm	4450
Width	mm	2350
Height	mm	3100
Empty weight	kg	5500
Noise level	dB (A)	< 76
Power connection		clockwise
Voltage		3x400V/N/PE
Frequency	Hz	50
Current intensity	A	116
Connected load	kW	72
Air quantity	NI/min	200
Air quantity Peak demand	NI/min	600
Media temperature	°C	10 – 60
pH-value	pH	6,5 – 11

## ET 200

	UNIT	VALUE
Nominal output	l/h	200
Energy requirement in operation	kWh/m <sup>3</sup>	from 50
<b>Dimensions</b>		
Length	mm	2500
Width	mm	1580
Height	mm	2600
Empty weight	kg	2300
Noise level	dB (A)	< 76
Power connection		clockwise
Voltage		3x400V/N/PE
Frequency	Hz	50
Current intensity	A	68
Connected load	kW	42
Air quantity	NI/min	100
Air quantity Peak demand	NI/min	300
Media temperature	°C	10 – 60
pH-value	pH	6,5 – 11

## ET 250

	UNIT	VALUE
Nominal output	l/h	250
Energy requirement in operation	kWh/m <sup>3</sup>	from 48
<b>Dimensions</b>		
Length	mm	2900
Width	mm	1750
Height	mm	2600
Empty weight	kg	2900
Noise level	dB (A)	< 76
Power connection		clockwise
Voltage		3x400V/N/PE
Frequency	Hz	50
Current intensity	A	75
Connected load	kW	47
Air quantity	NI/min	100
Air quantity Peak demand	NI/min	300
Media temperature	°C	10 – 60
pH-value	pH	6,5 – 11

## ET 350

	UNIT	VALUE
Nominal output	l/h	350
Energy requirement in operation	kWh/m <sup>3</sup>	from 45
<b>Dimensions</b>		
Length	mm	2900
Width	mm	1750
Height	mm	2600
Empty weight	kg	2900
Noise level	dB (A)	< 76
Power connection		clockwise
Voltage		3x400V/N/PE
Frequency	Hz	50
Current intensity	A	75
Connected load	kW	47
Air quantity	NI/min	100
Air quantity Peak demand	NI/min	300
Media temperature	°C	10 – 60
pH-value	pH	6,5 – 11

## ET 1000

	UNIT	VALUE
Nominal output	l/h	1000
Energy requirement in operation	kWh/m <sup>3</sup>	from 35
<b>Dimensions</b>		
Length	mm	4450
Width	mm	2800
Height	mm	3100
Empty weight	kg	8000
Noise level	dB (A)	< 76
Power connection		clockwise
Voltage		3x400V/N/PE
Frequency	Hz	50
Current intensity	A	180
Connected load	kW	112
Air quantity	NI/min	200
Air quantity Peak demand	NI/min	600
Media temperature	°C	10 – 60
pH-value	pH	6,5 – 11

## ET 1500

	UNIT	VALUE
Nominal output	l/h	1500
Energy requirement in operation	kWh/m <sup>3</sup>	from 35
<b>Dimensions</b>		
Length	mm	4450
Width	mm	2800
Height	mm	3100
Empty weight	kg	8000
Noise level	dB (A)	< 76
Power connection		clockwise
Voltage		3x400V/N/PE
Frequency	Hz	50
Current intensity	A	195
Connected load	kW	120
Air quantity	NI/min	200
Air quantity Peak demand	NI/min	600
Media temperature	°C	10 – 60
pH-value	pH	6,5 – 11

# 03



## 03 ULTRAFILTRATION

03/1	THE PERFECT SOLUTION	PAGE 38
03/2	THE ADVANTAGES	PAGE 39
03/3	THE ECONOMY	PAGE 39
03/4	THE PROCESS	PAGE 40
03/5	THE DIAPHRAGM / DIAGRAM	PAGE 41
03/6	THE PARTICLE RATINGS	PAGE 41
03/7	A LOOK AT THE TECHNOLOGY	PAGE 42
03/8	TECHNICAL DATA	PAGE 44

## DID YOU KNOW THAT WASHING WATER CAN ALSO BE TREATED?

Efficient washing water maintenance during on-going operations



### EXTERNAL DISPOSAL

STRENUOUS AND EXPENSIVE

- HIGH EFFORT
- COST-INTENSIVE
- SHORTENED SERVICE LIFE



### IN-HOUSE SOLUTION

ECONOMICAL WITHOUT STOPPING THE MACHINERY

- LOW EFFORT
- ECONOMICAL
- EXTENDED SERVICE LIFE

## SPARE YOURSELF THE COST OF EXPENSIVE EXTERNAL DISPOSAL.

You still have your washing water disposed of every two weeks for a lot of hard-earned money? The cleaning system also needs intensive maintenance and care at regular intervals? With MKR ultrafiltration you spare yourself expensive external disposal and your cleaning system will also thank you.

With our ultrafiltration, your washing water is treated, cleaned, filtered and returned to the cleaning processes in bypass mode. This extends the service life of your system by up to 2000 % and reduces your disposal costs many times over. Our ultrafiltration unit ensures uniformly low residual soiling of your components and continuous operation, without system standstill times.

#### THE ADVANTAGES AT A GLANCE

- ✓ EXTENSION OF THE SERVICE LIFE OF THE WASHING BATHS OF THE PART CLEANING SYSTEM
- ✓ SEPARATION OF ULTRAFINE PARTICLES, EMULSIONS AND OILS FROM ALL AQUEOUS LIQUIDS
- ✓ EXTENSION OF SERVICE LIFE OF PRETREATMENT UNITS
- ✓ VERSIONS FOR MANUAL/AUTOMATIC OPERATION
- ✓ ARE MADE OF STAINLESS STEEL

## YOU WANT TO EXTEND THE SERVICE LIFE OF YOUR PLANT?

UP TO **-85%**

COST SAVINGS IN TOTAL

UP TO **2.000%**

SERVICE LIFE EXTENSION

UP TO **-90%**

DISPOSAL COSTS



## ULTRA-EFFECTIVE WITHOUT CHEMICALS.

The MKR diaphragm achieves what no standard filter can do.

Ultrafiltration involves the purely mechanical separation of mechanicals, without any use of chemicals. This is achieved not with a standard filter, but with the membrane elements of the MKR ultrafiltration systems. Here the material is separated due to the molecular size and shape.

Depending on the application, different membranes are used in the ultrafiltration, for example, to remove the oil load from washing-active substances.

Use of this selective, pressure-operated membrane process is one of the safest and most reliable treatment solutions. MKR ensures its ultrafiltration systems are high quality by using stainless steel. MKR ultrafiltration units are used to maintain and extend the service life of degreasing and cleaning baths.

The unit removes introduced emulsions, oils and floating solid particles. Suitable for splitting emulsions and other process media.

### How ultrafiltration works

A particular advantage of the ultrafiltration membranes is their special surface and the asymmetrical basic structure. All substances that cannot flow through the membranes are retained on the surface and do not get into the membrane matrix.

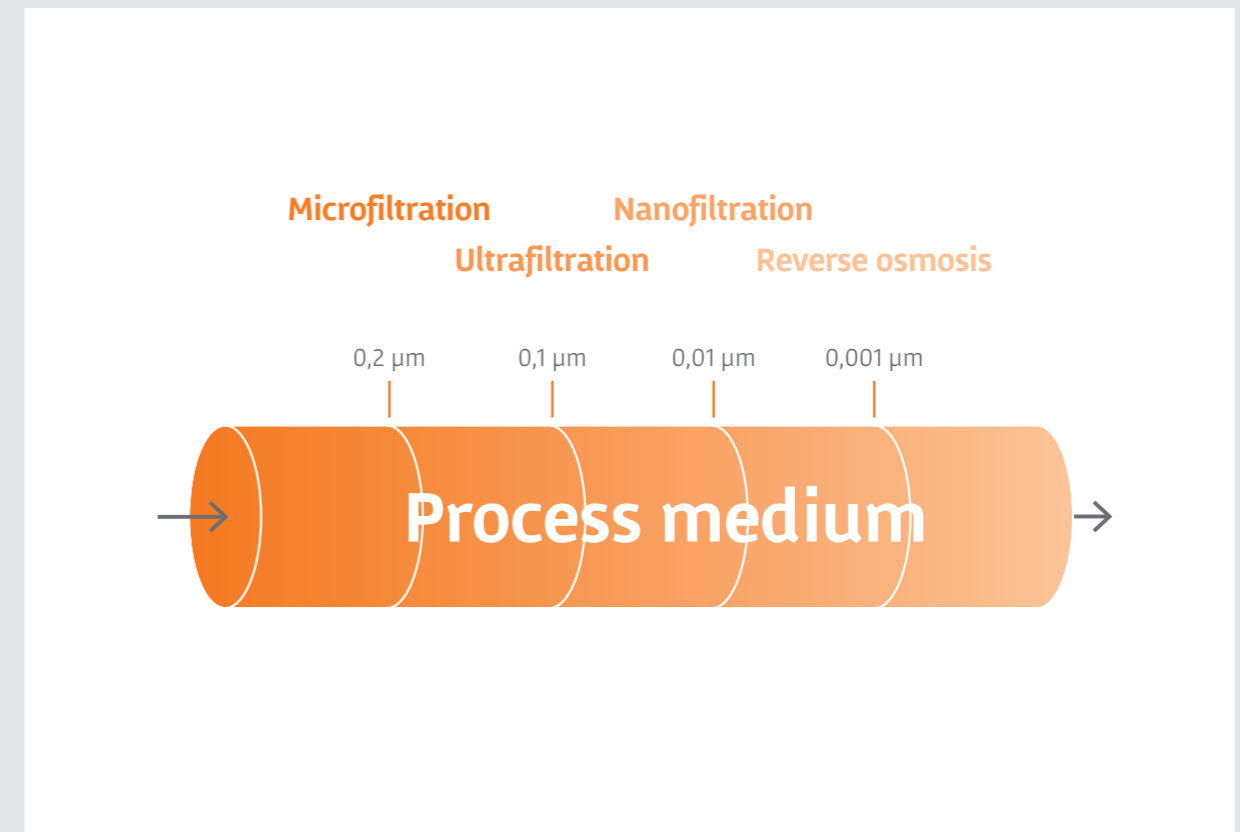
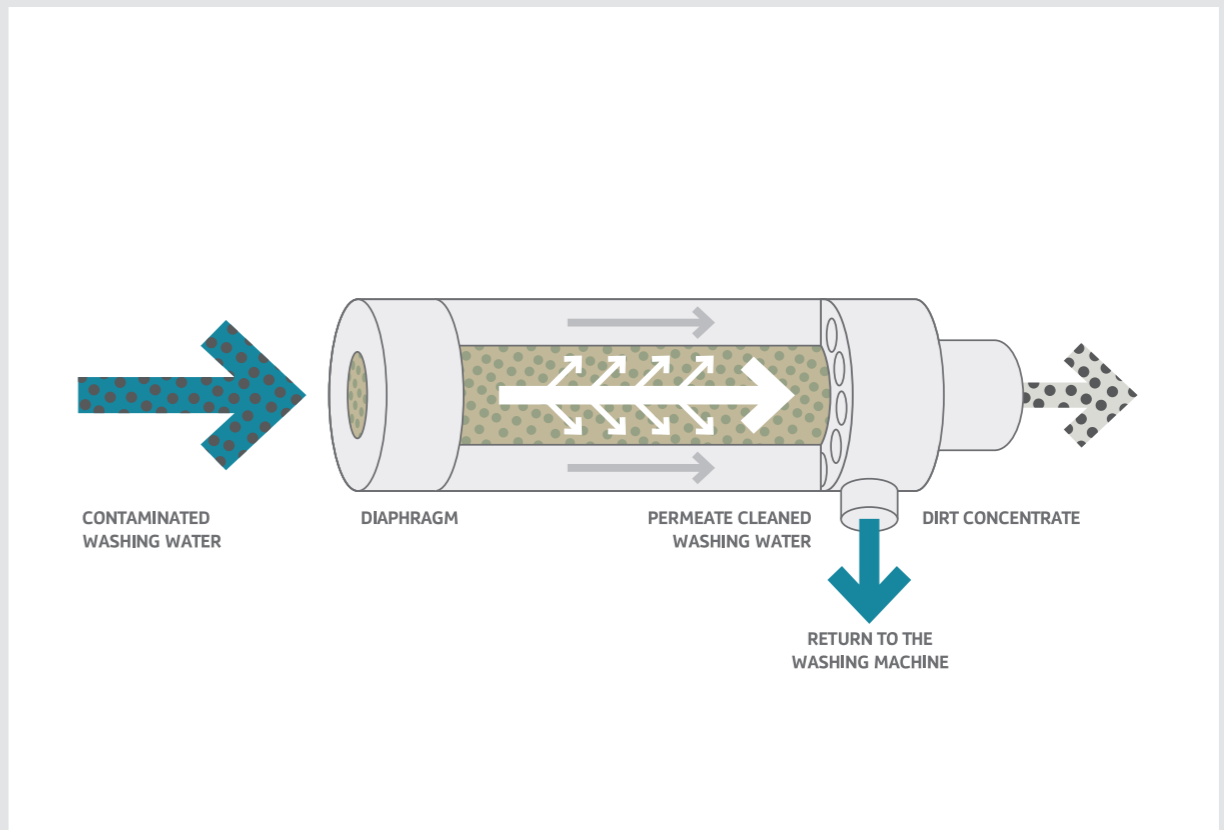

# BRILLIANT TECHNOLOGY MADE OF STAINLESS STEEL AND CERAMIC – 6 TECHNICAL HIGHLIGHTS.

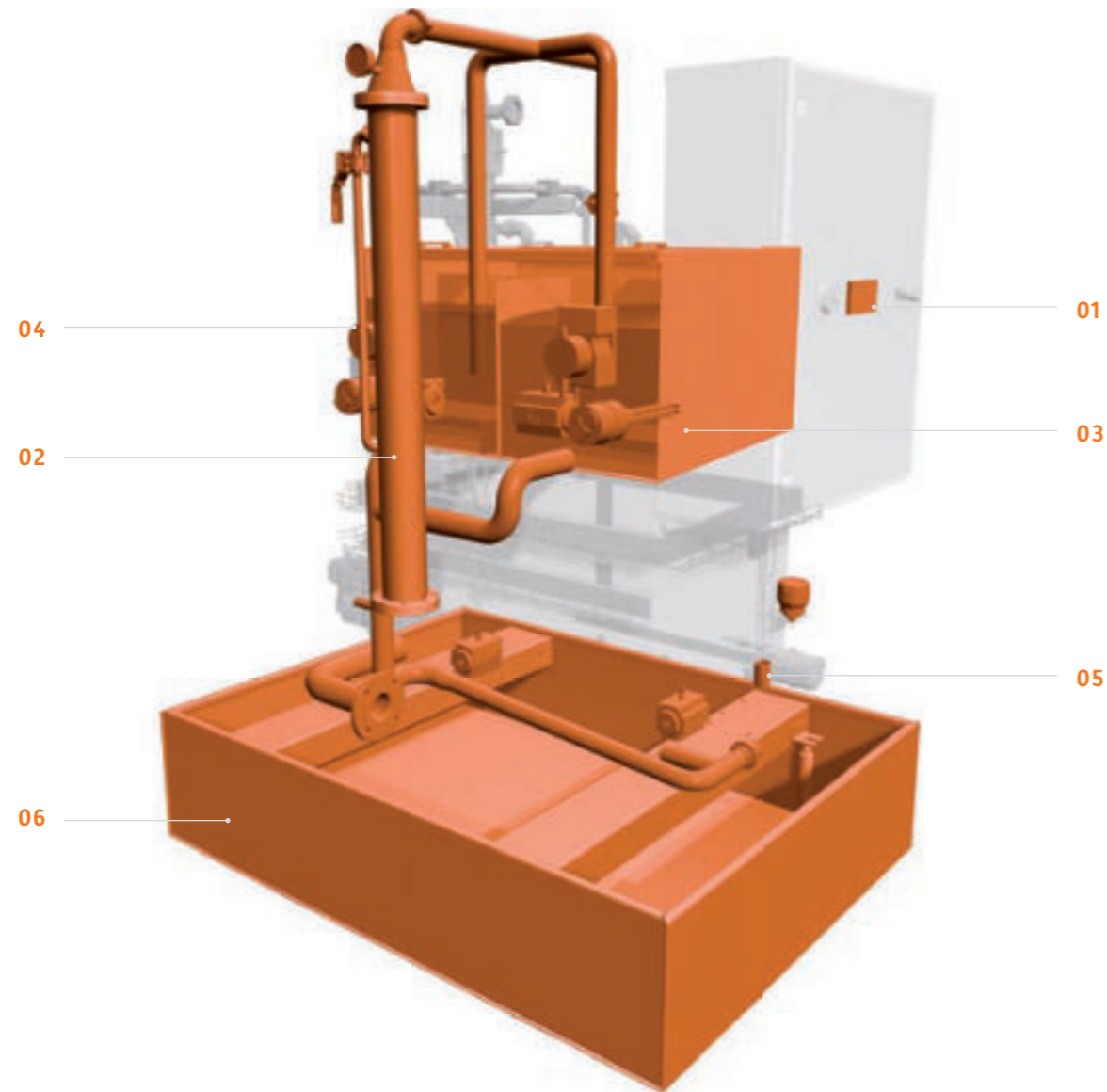

Our MKR ultrafiltration units are characterised by simple operation and cleaning and the lowest possible operating costs. The components are mainly made of high-quality stainless steel and ceramic and thus ensure a long life for the unit. The particle rating of the unit is

additionally adjustable, so that in some cases, nanoparticles and microparticles can be filtered out by diaphragms without use of chemicals.

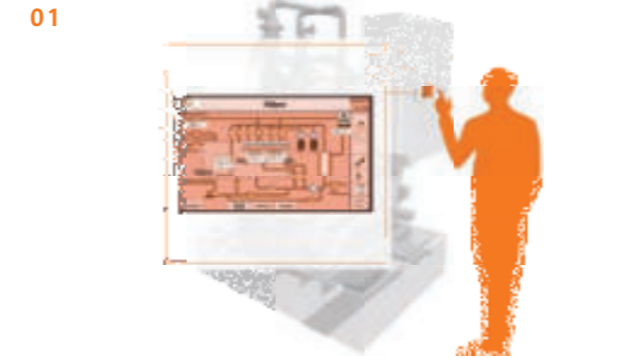

**01 INTUITIVE PLANT CONTROL**  
The intelligent and intuitive plant control automatically concentrates with variably adjustable operating parameters.



**02 MODULAR FILTER SYSTEM**  
The modular system offers a filter area from 1 to 48 m<sup>2</sup>. The permeate output varies from 100 to 5000 l/h. The membrane filter ceramics are available in different versions and particle ratings.



**03 LOW MAINTENANCE EFFORT**  
Care of the unit requires little effort and is convenient, due to the integrated automatic self-cleaning for acidic and alkaline cleaning runs.



**04 ADJUSTABLE FILTER FINENESS**  
Easy use of different particle ratings by changing the ceramic diaphragms, and with which the microfiltration, ultrafiltration and parts of nanofiltration ranges can be covered.



**05 QUALITY MADE OF STAINLESS STEEL**  
The unit, which operates completely autonomously, with its sensors integrated into a closed system, carries out the complete ultrafiltration process fully automatically.



**06 PRACTICAL CONTAINMENT BASIN**  
A sensor-monitored spillage tray (conforms to the WHG (German Water Management Act)) is available.

# THE ULTRAFILTRATION TECHNOLOGY IN DETAIL.



## UC 1

	UNIT	VALUE
<b>Capacity</b>		
Working tank	approx. l	500
Rinsing tank (on 2x) approx.	l	50
<b>Dimensions</b>		
Length	mm	1700
Width	mm	1350
Height	mm	2150
Empty weight	kg	650
Output, permeate	L/h	50-300
(depending on the cut-off range, higher outputs are possible)		
Suction head	m	2
Rinsing tank heater	kW	3
pH-value	pH	4 - 13
Temperature	°C	< 65
Compressed air connection	bar	mind. 6
Power connection	V/A	400/16
3 Phasen, N und PE	Hz	50
Connected load	kW/A	8/16
<b>Dimensions with optional safety spillage tray</b>		
Length	mm	1700
Width	mm	1350
Height	mm	2350

## UC 2

	UNIT	VALUE
<b>Capacity</b>		
Working tank	approx. l	600
Rinsing tank (on 2x) approx.	l	60
<b>Dimensions</b>		
Length	mm	1700
Width	mm	1350
Height	mm	2150
Empty weight	kg	770
Output, permeate	L/h	100-600
(depending on the cut-off range, higher outputs are possible)		
Suction head	m	2
Rinsing tank heater	kW	3
pH-value	pH	4 - 13
Temperature	°C	< 65
Compressed air connection	bar	mind. 6
Power connection	V/A	400/45
3 Phasen, N und PE	Hz	50
Connected load	kW/A	18/45
<b>Dimensions with optional safety spillage tray</b>		
Length	mm	1700
Width	mm	1350
Height	mm	2350

## UC 4

	UNIT	VALUE
<b>Capacity</b>		
Working tank	approx. l	900
Rinsing tank (on 2x) approx.	l	100
<b>Dimensions</b>		
Length	mm	2200
Width	mm	2000
Height	mm	2300
Empty weight	kg	850
Output, permeate	L/h	200-1200
Suction head	m	2
Rinsing tank heater	kW	3
pH-value	pH	4 - 13
Temperature	°C	< 90
Power connection	V/A	400/35
3 Phasen, N und PE	Hz	50
Connected load	kW/A	18/35
<b>Dimensions with optional safety spillage tray</b>		
Length	mm	2200
Width	mm	2000
Height	mm	2600

## UC 6

	UNIT	VALUE
<b>Capacity</b>		
Working tank	approx. l	1500
Rinsing tank (on 2x) approx.	l	150
<b>Dimensions</b>		
Length	mm	2600
Width	mm	2000
Height	mm	2500
Empty weight	kg	950
Output, permeate	L/h	800-1500
Suction head	m	2
Rinsing tank heater	kW	3
pH-value	pH	4-13
Temperature	°C	< 90
Power connection	V/A	400/35
3 Phasen, N und PE	Hz	50
Connected load	kW/A	18/35
<b>Dimensions with optional safety spillage tray</b>		
Length	mm	2600
Width	mm	2000
Height	mm	2850

## UC 8

	UNIT	VALUE
<b>Fassungsvermögen</b>		
Working tank	approx. l	2500
Rinsing tank (on 2x) approx.	l	200
<b>Dimensions ca.</b>		
Length	mm	2800
Width	mm	2000
Height	mm	2400
Empty weight	ca. t	1,5
Output, permeate	L/h	800-1500
(depending on the cut-off range, higher outputs are possible)		
Heater per rinsing tank	kW	6*
*also higher, depending on the requirement		
Working tank heater	kW	2 x 9*
pH-value	pH	4 - 13
Temperature	°C	< 65
Compressed air connection	bar	min. 6
Power connection	V/A	400/80
3 Phasen, N und PE	Hz	50
Connected load	kW/A	50/80
*also higher, depending on the requirement		
<b>Media connections</b>		
Inlet		1 1/2"
Permeate return		3/4"
Drain		1 1/2"
Fresh water		1"
Compressed air	Push-on nipple	DN 7,2

## UC 12

	UNIT	VALUE
<b>Capacity</b>		
Working tank	approx. l	2500
Rinsing tank (on 2x) approx.	l	200
<b>Dimensions approx.</b>		
Length	mm	2800
Width	mm	2200
Height	mm	2400
Empty weight	approx. t	1,6
Leistung, Permeat	L/h	1200-2500
(depending on the cut-off range, higher outputs are possible)		
Heater per rinsing tank	kW	6*
*also higher, depending on the requirement		
Working tank heater	kW	2 x 9*
pH-value	pH	4 - 13
Temperature	°C	< 65
Compressed air connection	bar	mind. 6
Power connection	V/A	400/80
3 Phasen, N und PE	Hz	50
Connected load	kW/A	50/80
*also higher, depending on the requirement		
<b>Media connections</b>		
Inlet		1 1/2"
Permeate return		1"
Drain		1 1/2"
Fresh water		1"
Compressed air	Push-on nipple	DN 7,2

# ONE CLEAN SOLUTION FOR EVERY PROBLEM.

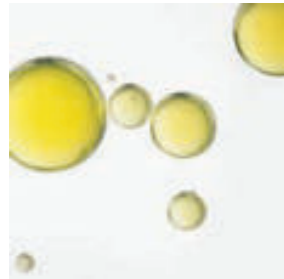

## OIL

Oil is indispensable in everyday operations. Ultrafine particles and other contaminants reduce this effect. Problem solutions and equipment from MKR enable all kinds of process oils to be reclaimed on site.

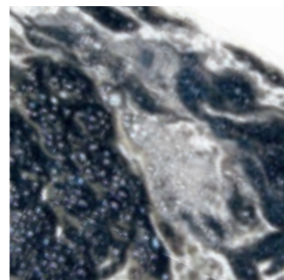

## EMULSION

In metalworking, emulsions are still indispensable. Their effect is reduced successively by bacteria and tramp oils. MKR offers filtering and cleaning systems that can be integrated into the production. This extends significantly the service lives of emulsions and other process media as well as tools.



## WASHING MEDIA / PRETREATMENT MEDIA

Whether parts cleaning or parts coating: MKR technology enables a closed cycle, including for the washing process.



## USED MEDIA

The MKR product range includes units for splitting aqueous used media efficiently. The water recovered in this way even exceeds the quality of tapwater, for example, the total hardness, and remains in the company – which also reduces disposal or drainage costs.

A decorative graphic of a goldfish swimming in the upper right corner of the page.

A series of horizontal lines for taking notes, starting from the top of the page and extending down to the bottom.



## PRODUCT FAMILIES AT A GLANCE.

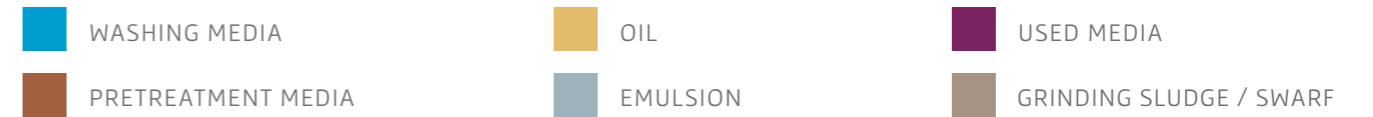

### 01 VACUUM AND FILTER TROLLEY



- ✓ PERFECT EMULSION MAINTENANCE FOR INDIVIDUALLY FILLED MACHINES
- ✓ EMULSION CHANGE IN A VERY SHORT TIME
- ✓ SHORT MACHINE STANDSTILL TIMES
- ✓ VERY SIMPLE HANDLING
- ✓ CAN BE USED FOR METALWORKING FLUIDS OR CUTTING-MACHINING OILS

SF 250  
SF 500  
SF 700  
SF 1000  
SF 400T  
SF 500S



SF 500

### 02 EVAPORATORS

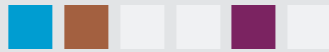

- ✓ LOW POWER CONSUMPTION
- ✓ MECHANICAL FOAM BREAKER
- ✓ ADDITIONAL ANTI-FOAMER CHEMICALS NOT NECESSARY
- ✓ BEST DISTILLATE QUALITY
- ✓ RECOVERY OF PROCESS WATER

ET 50  
ET 75  
ET 100  
ET 150  
ET 200  
ET 500  
ET 750  
ET 1000  
ET 1500



ET 150

### 03 ULTRAFILTRATION

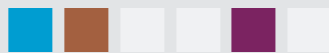

- ✓ EXTENSION OF THE SERVICE LIFE OF THE WASHING BATHS OF THE PART CLEANING SYSTEMS
- ✓ SEPARATION OF ULTRAFINE PARTICLES, EMULSIONS AND OILS
- ✓ FROM ALL AQUEOUS LIQUIDS
- ✓ EXTENSION OF SERVICE LIFE OF PRETREATMENT UNITS
- ✓ VERSIONS FOR MANUAL / AUTOMATIC OPERATION

UC 1-24



UC 12

### 04 DISC STACK CENTRIFUGES \*



- ✓ EXACT SEPARATION OF INTERFERING TRAMP OILS
- ✓ VERY FINE CLEANING WITHOUT CONSUMPTION OF FILTER AIDS  $\geq 2$
- ✓ REDUCTION OF DISPOSAL AND CONSUMPTION COSTS
- ✓ SELECTABLE UNIT TYPE: SLUDGE REMOVAL, DE-OILING OR COMBINED
- ✓ CLEANING IN THE BYPASS

OTC 350  
OTC 350 VA  
OSE 500  
OSE 2000



TB 250

\* For info on our centrifuges, visit [www.mkr-metzger.de](http://www.mkr-metzger.de) or request a product brochure directly from us.

### 05 DRUM CENTRIFUGES \*



- ✓ SEPARATION OF SLUDGE / SOLIDS / TRAMP OILS
- ✓ VERY FINE CLEANING WITHOUT CONSUMPTION OF FILTER AIDS  $\geq 2$
- ✓ MANUAL AND AUTOMATIC DE-SLUDGING UNITS
- ✓ CAN BE USED FOR INDIVIDUALLY FILLED SYSTEMS AND CENTRAL PLANTS
- ✓ CLEANING IN THE BYPASS

T 710  
T 700  
T 8000



T 710

\* For info on our centrifuges, visit [www.mkr-metzger.de](http://www.mkr-metzger.de) or request a product brochure directly from us.

### 06 TRAMP OIL SEPARATORS \*



- ✓ EXTENSION OF THE VISUALLY GOOD CONDITION OF THE EMULSION AND ODOUR IMPROVEMENT
- ✓ BYPASS CLEANING WITHOUT MACHINE STANDSTILL
- ✓ REDUCTION OF DISPOSAL COSTS
- ✓ SHORT PAYBACK PERIOD
- ✓ REDUCTION OF GERMS IN METALWORKING FLUIDS

TM 450 UV  
TB 250



TB 250

\* For info on our tramp oil separators, visit [www.mkr-metzger.de](http://www.mkr-metzger.de) or request a product brochure directly from us.



## CONTACT

Contact us. Benefit from our competent advice without obligation.  
We look forward to hearing from you!

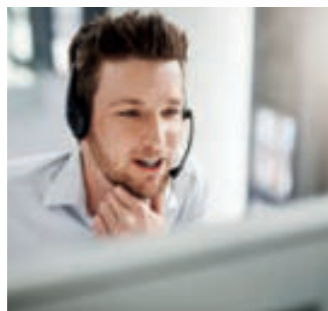

### **MKR METZGER GMBH RECYCLINGSYSTEME**

Rappenfeldstrasse 4  
86653 Monheim, Germany  
Tel +49 (0) 9091 50 00 0  
Fax +49 (0) 9091 50 00 30

[info@mkr-metzger.de](mailto:info@mkr-metzger.de)  
[www.mkr-metzger.de](http://www.mkr-metzger.de)

 **HOTLINE +49 (0) 9091 50 00 0**

## MKR WORLDWIDE

Australia, Belgium, Brazil, Bulgaria, China, Denmark, England, Finland, France, Greece, India, Iran, Ireland, Italy, South Korea, Croatia, Liechtenstein, Luxembourg, Malaysia, Mexico, Netherlands, Norway, Austria, Poland, Portugal, Russia, Romania, Sweden, Switzerland, Slovakia, Slovenia, Spain, South Africa, Taiwan, Czech Republic, Turkey, Hungary, USA





**cleaning  
systems  
for liquids**

MKR Metzger GmbH  
Recyclingsysteme  
Rappenfeldstrasse 4  
86653 Monheim, Germany  
Tel +49 (0) 9091 50 00 0  
Fax +49 (0) 9091 50 00 30

[info@mkr-metzger.de](mailto:info@mkr-metzger.de)  
[www.mkr-metzger.de](http://www.mkr-metzger.de)

Technical changes reserved.  
Last revised September 2019.