



cleaning  
systems  
for liquids



# Machine cleaning



# Save time and money when cleaning the machine

The fast complete cleaning of all your machine tools



**up to 8 hours**  
tedious and time-consuming



**about 0,5 hours**  
efficient and economical

The previous path of industrial complete cleaning was laborious: With industrial vacuum cleaners, high-pressure cleaners, oil shovels and rags, that became part of it heavily loaded dirt tackled by hand. Depending on the size of the company that takes hours - or even days - of arduous work until all elements are cleaned - valuable Working time was lost as a result. Those days are over.

Our intelligent, perfectly thought-out suction and filter trolleys enable a Complete cleaning in just 30 minutes. Best of all: You save time, energy, valuable manpower and increase in the long term significantly the productivity of your company.

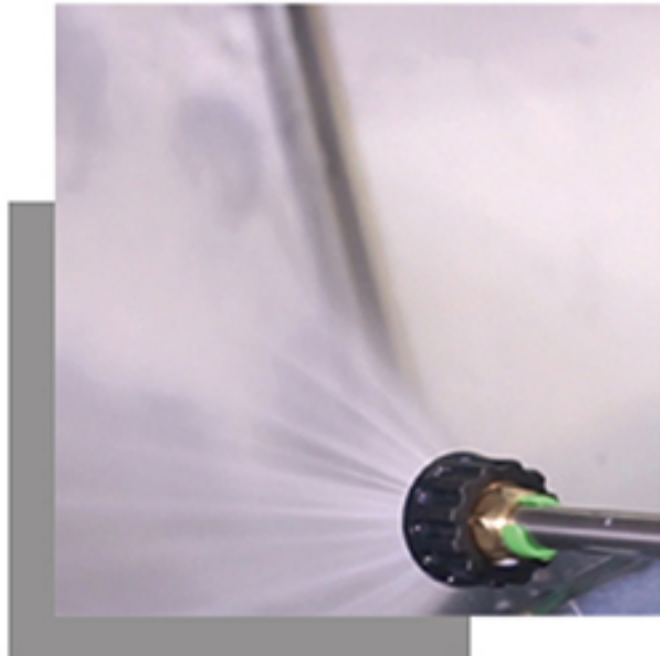

## The advantages at a glance:

- SHORT MACHINE DOWNTIMES – SIMULTANEOUS
  - VACUUM (at up to 320 l/min)
  - FILTER (with 20 – 80µm)
  - CLEANING (high-pressure cleaning with up to 80 bar)
- PERFECT COOLING LUBRICANT & EMULSION CARE
- WASH BATH & EMULSION CHANGE IN SHORT TIME
- CLEANING OF MACHINE INTERIOR AND CONTAINERS
- COLLECTION OF CHIPS AND SANDING SLUDGE
- CAN BE USED AS A WET & DRY VACUUM CLEANER
- ALSO AVAILABLE IN STAINLESS STEEL (pH 4-11)



# Intelligently designed - 10 technical highlights

Our suction and filter trolleys are perfectly thought out and tailored to the needs of our customers. So are effectiveness and time savings guaranteed.

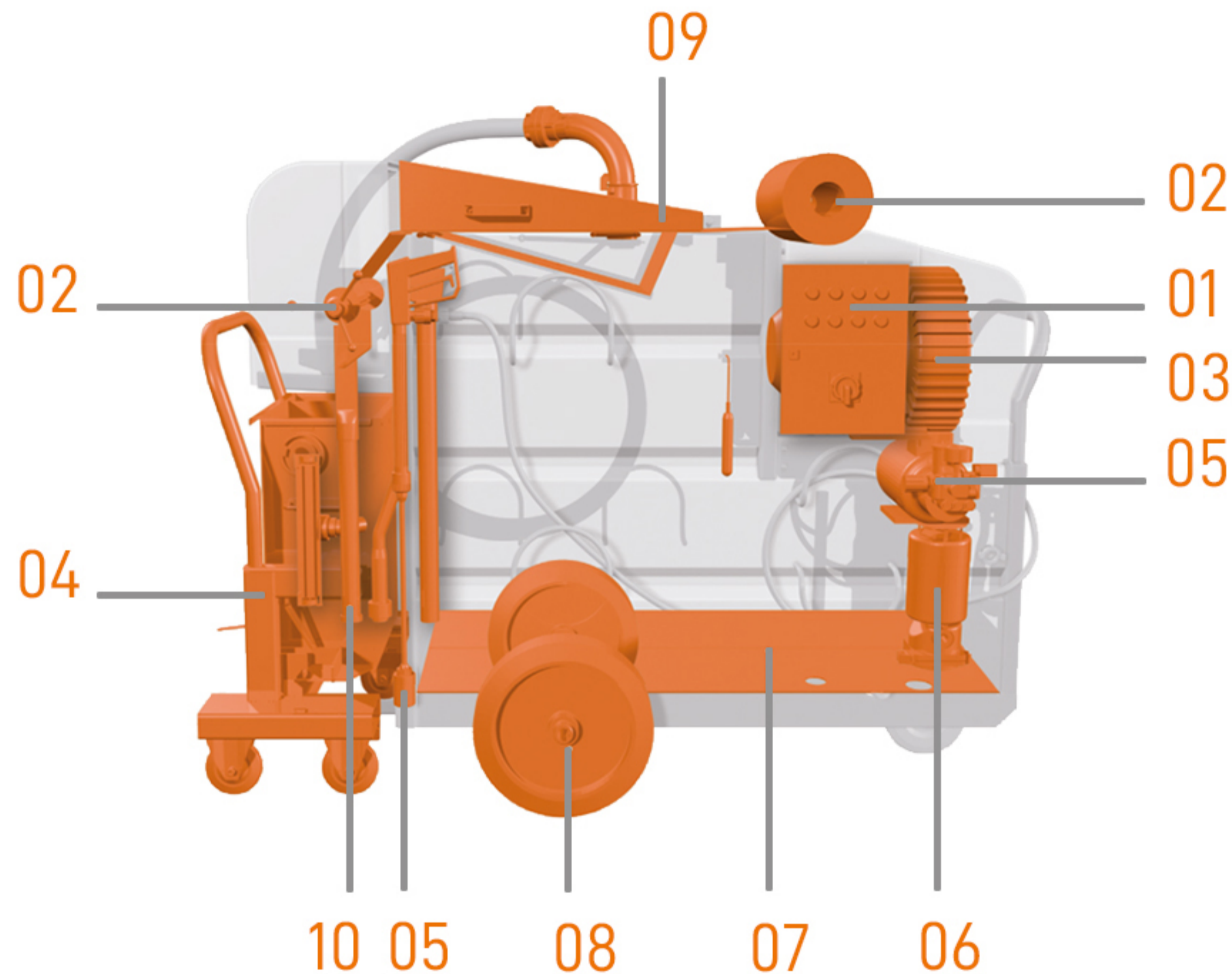

The MKR suction and filter trolleys have state-of-the-art intelligent technology. The efficiency and ease of handling of our SF series were of great importance to us right from the development and construction stage. And our engineers have achieved their goal: Many elements are designed for easy handling and maintenance and save the user valuable time, work and effort. Powerful pumps and practical tools for quick cleaning also contribute to making MKR vacuum and filter trolleys indispensable today.

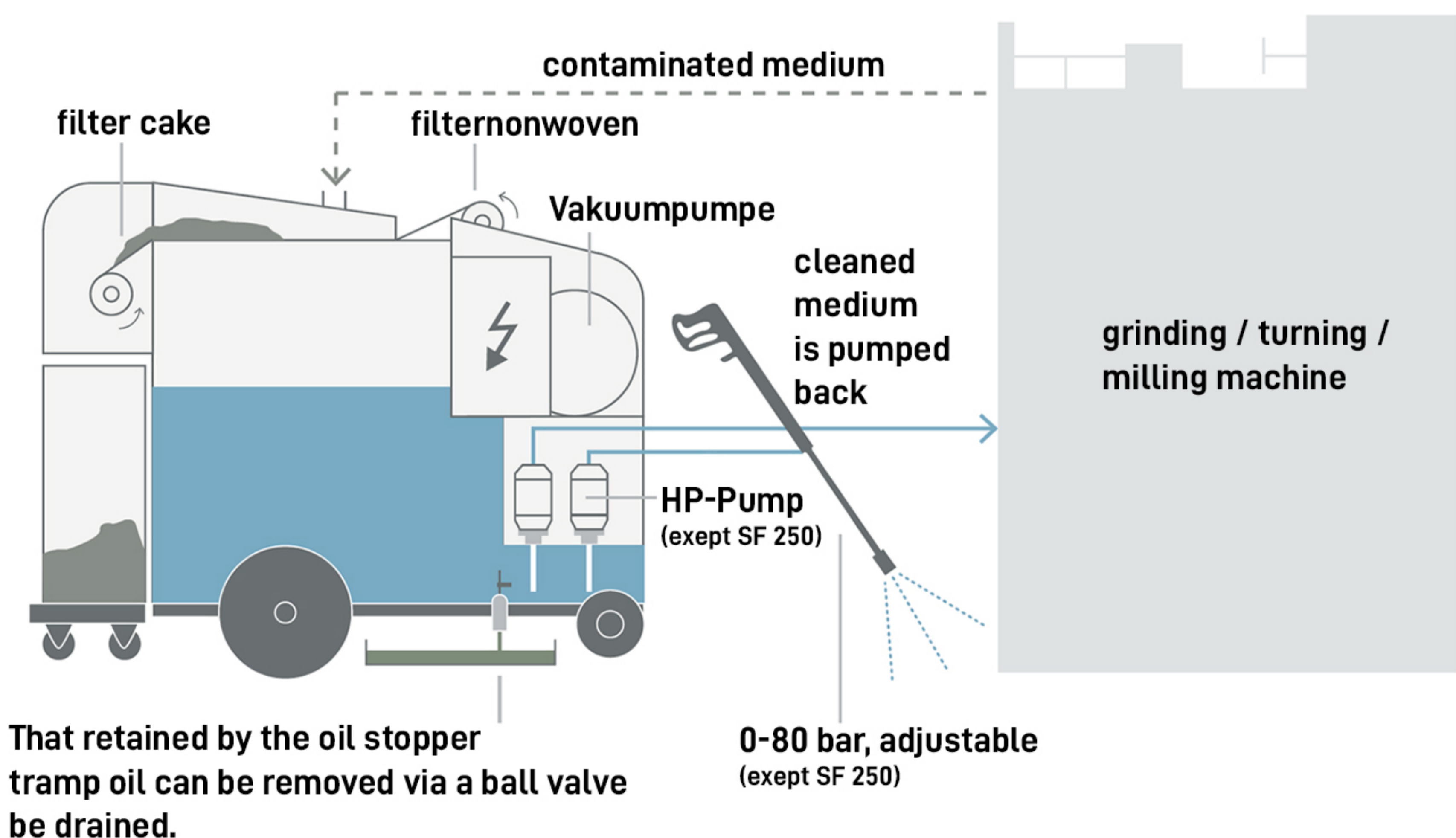



## 01 Easy operation

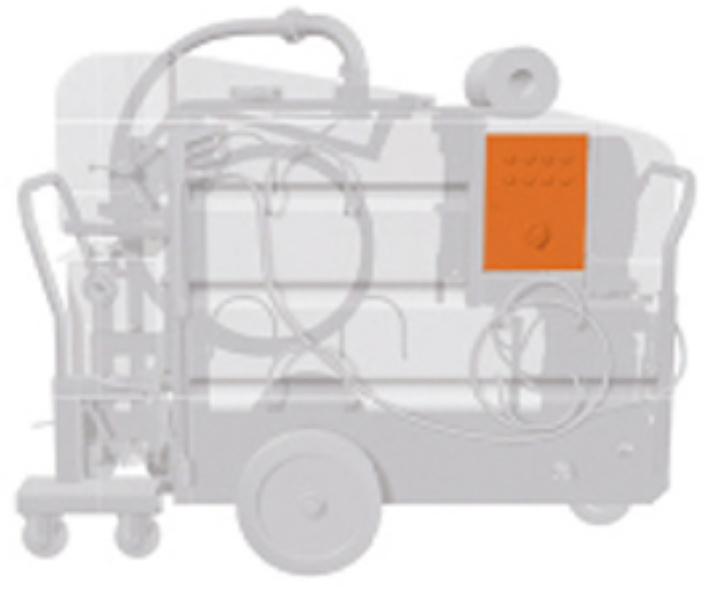

Simple and convenient operation of the three functions (suction, high cleaning and emptying).

## 02 Efficient filter nonwoven

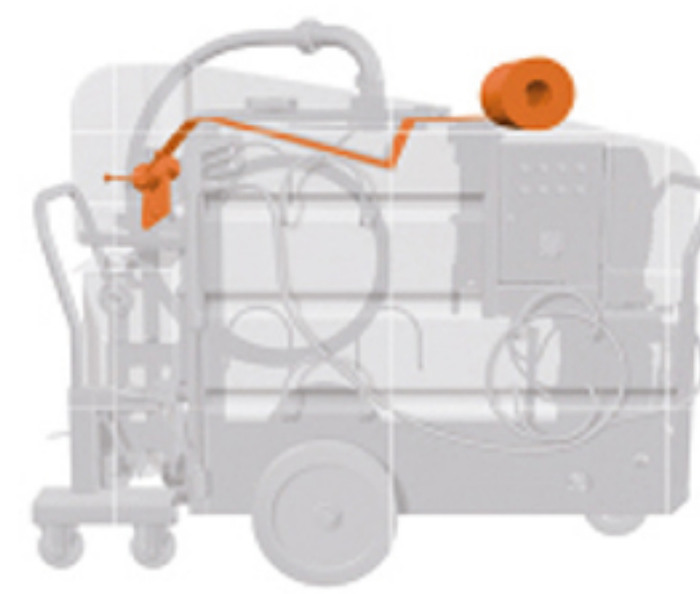

Efficient filter nonwoven with a filter fineness of up to 60  $\mu\text{m}$ . Easy separation of the filter cake from the nonwoven.

## 03 High-suction vacuum pump

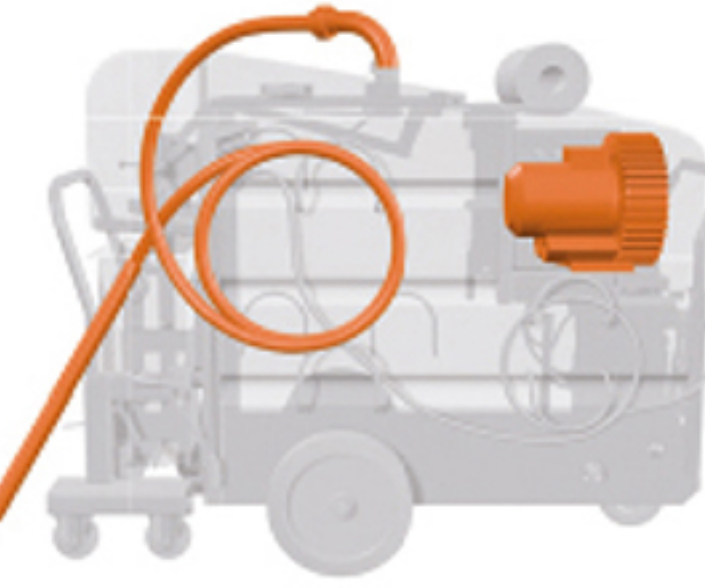

High-suction pump for extraction of process medium to be cleaned. Can be combined with other functions at the same time.

## 04 Convenient Disposal

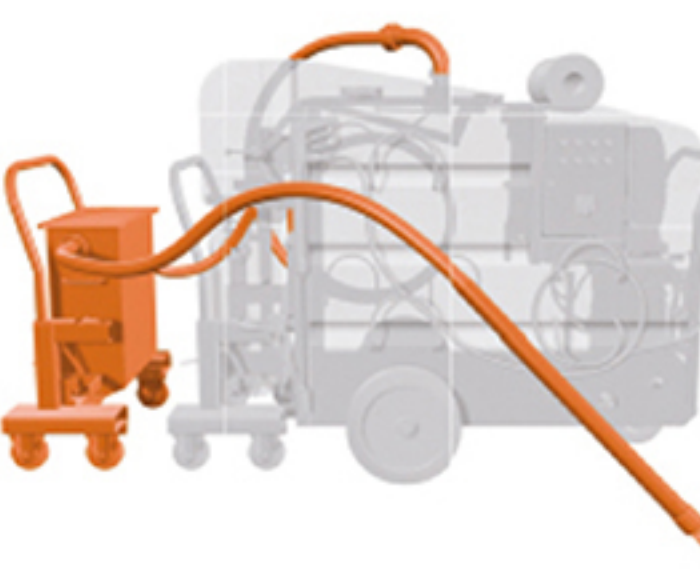

Integrated and mobile swarf trolley (with forklift pockets and pivotable) for comfortable pick-up and emptying.

## 05 Powerful high-pressure lance

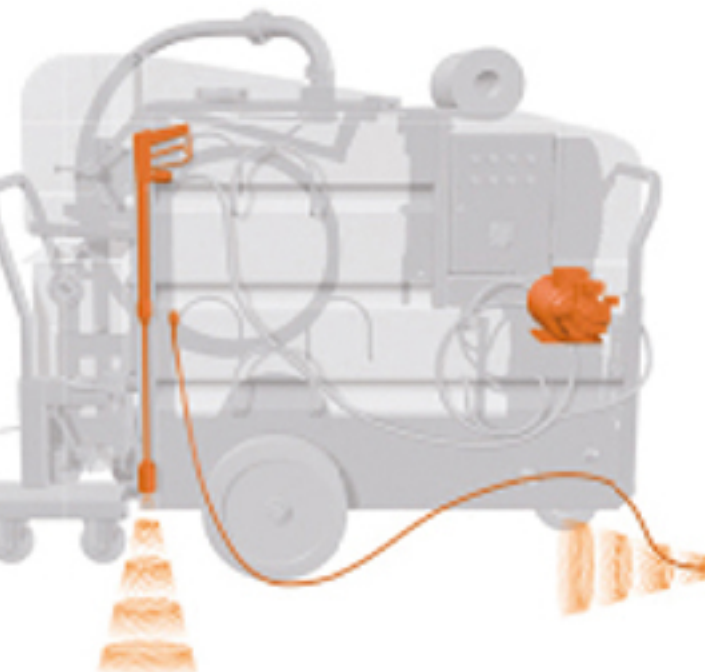

Powerful high pressure pump for operating the high pressure lance (up to 80 bar).

## 06 Efficient draining pump

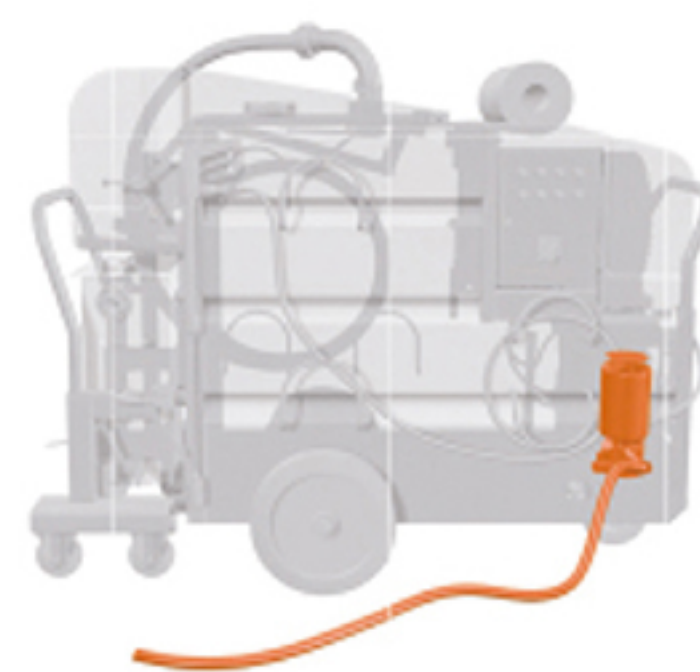

Efficient drain pump for returning the cleaned medium back into the production circuit (e.g. a machine tool).

## 07 Convenient draining

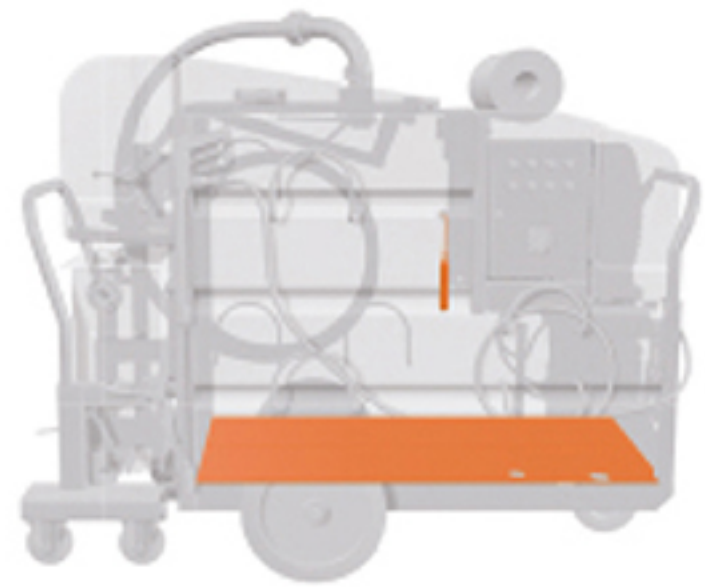

Inclined bottom for full emptying of the cleaned medium with level monitoring sensor.

## 08 Optimum freedom of movement

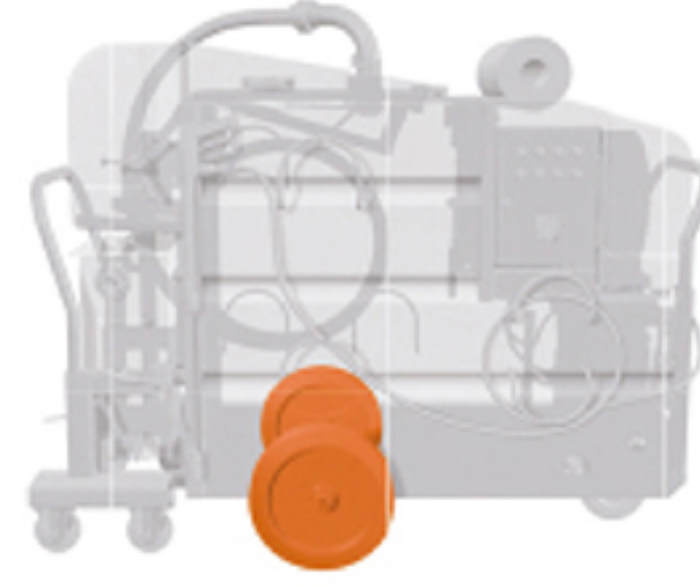

Large wheels (diameter 400 mm) for optimum freedom of movement in the production facility.

## 09 Easy cleaning

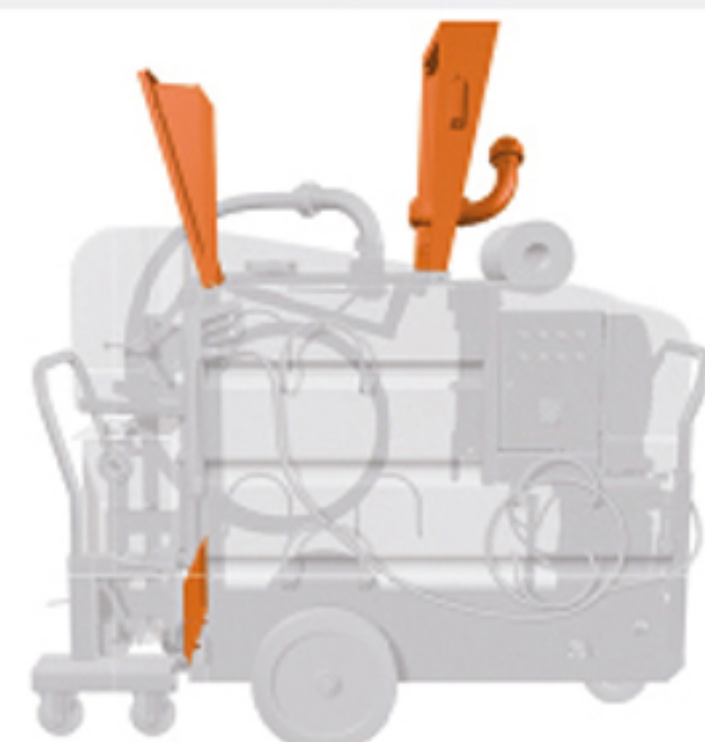

Best accessibility for easy cleaning of the unit including an further optional cleaning opening.

## 10 Auswahl an Saugdösen

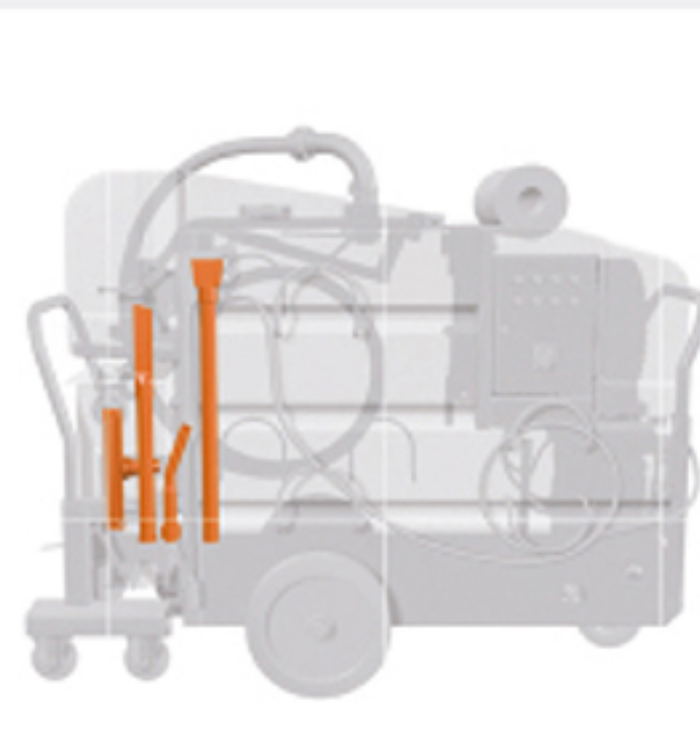

Large selection of different suction nozzles included (clean and space-saving stowable including drip tray).





## SF 250

UNIT VALUE

### Capacity

Main tank	approx. l	250
Swarf tray	approx. l	20

### Dimensions

Length	mm	1750
Width	mm	725
Height	mm	1250
Empty weight	kg	310

Suction head (stat.) mm WS		2000
Suction capacity	l/min	125
Temperature	°C	< 50
pH-value	pH	5 - 9,5
Noise level	dB (A)	< 75
Power connection	V/A	230/16
1 phase, N and PE	Hz	50
Connected load	kW/A	2,5/16



## SF 500

UNIT VALUE

### Capacity

Main tank	approx. l	500
Swarf remover	approx. l	60

### Dimensions

Length	mm	2000
Width	mm	800
Height	mm	1600
Empty weight	kg	420

Suction head (stat.) mm WS		2800
Intake flow	l/min	250
Temperature	°C	< 50
pH-value	pH	5 - 9,5
Noise level	dB (A)	73
Power connection	VA	400/16
3 phases, PE	Hz	50
Connected load	kW/A	7/16



## SF 700

UNIT VALUE

### Capacity

Main tank	approx. l	700
Swarf remover	approx. l	80

### Dimensions

Length	mm	2400
Width	mm	920
Height	mm	1600
Empty weight	kg	560

Suction head (stat.) mm WS		3700
Intake flow	l/min	320
Temperature	°C	< 50
pH-value	pH	5 - 9,5
Noise level	dB (A)	75
Power connection	VA	400/16
3 phases, PE	Hz	50
Connected load	kW/A	7/16



## SF 1000

UNIT VALUE

### Capacity

Main tank	approx. l	1000
Swarf remover	approx. l	80

### Dimensions

Length	mm	2930
Width	mm	920
Height	mm	1600
Empty weight	kg	690

Suction head (stat.) mm WS		3700
Intake flow	l/min	320
Temperature	°C	< 50
pH-value	pH	5 - 9,5
Noise level	dB (A)	75
Power connection	VA	400/16
3 phases, PE	Hz	50
Connected load	kW/A	7/16



## SF 400 T

UNIT VALUE

### Capacity

Main tank	approx. l	400
Swarf remover	approx. l	80
Oil tank	approx. l	50

### Dimensions

Length	mm	2900
Width	mm	910
Height	mm	1500
Empty weight	kg	865

Suction head (stat.) mm/WS		2600
Intake flow	l/min	250
Temperature max.	°C	< 50
pH-value	pH	5 - 9,5
Separator flow rate	l/h	800-3000
Separation particle size	µm	2 - 5
Noise level	dB(A)	78
Power connection	V/A	400/16
3 phases, PE	Hz	50
Connected load	kW/A	5,5/13



## SF 500 S

UNIT VALUE

### Capacity

Main tank	approx. l	400
Clean tank	approx. l	160
Oil tank	approx. l	25
Swarf remover	approx. l	80

### Dimensions

Length	mm	2700
Width	mm	920
Height	mm	1500
Empty weight	kg	630

Suction head (stat.) mm WS		2600
Intake flow	l/min	250
Separator flow rate	l/h	500
Separation particle size	µm	> 2
Temperature	°C	< 50
pH-value	pH	5 - 9,5
Noise level	dB (A)	75
Power connection	V/A	400/16
3 phases, PE	Hz	50
Connected load	kW	9/16



# The success Story tradition becomes innovation.

Coolant treatment  
**Machine cleaning**  
Wastewater recycling  
Washwater treatment



**2023**

**ET MaXx ZLD**  
*ET MaXx ZLD*

**2001**

**Fremdölabscheider**  
*Tramp Oil Separator*



**1997**

**Verdampfer**  
*Evaporator*

**1996**

**Ultrafiltration**  
*Ultrafiltration*



**1992**

**Zentrifugen**  
*Centrifuges*

**1990**

**Saug- und Filterwagen**  
*Suction- and Filter Cart*



cleaning  
systems  
for liquids

**MKR Metzger GmbH**  
**Recyclingsysteme**  
Rappenfeldstrasse 4  
D-86653 Monheim  
Tel +49 (0) 9091 50 00 0  
Fax +49 (0) 9091 50 00 30

info@mkr-metzger.de  
www.mkr-metzger.de

